



Product Guide 2019

for Hydrocarbons



Preface

This catalogue contains two sections. The first section is related to products which are intended to be applied in systems located in an environment according to ATEX definition (Zone 2). These products are manufactured under consideration of appropriate standards and directives.

The second section is only related to products intended to be used in systems with R290/R1270 refrigerant but having appropriate solution in order to prevent explosion risk at any time. (Non-risk zone)

The definition of "non-risk zone" is related to the environment of the installed device and no special product requirement is needed except material compatibility of part in contact with refrigerant.

These products are not ATEX certified may under no circumstance be used within areas with explosive or flammable atmosphere and that the owner, designer and installer are responsible to ensure strict compliance with related regulation and avoid any such risk.

Products in section 1:

Page 4-31

Products are intended for use in systems located in an environment according definition of ATEX (Zone 2)

Products in section 2:

Page 32-46

Products are intended for use in non-explosive environment (Products do not comply with ATEX requirements)

General Information

Technical data provided herein is collected with scrutiny. However, errors and misprinting remain reserved. The technical data is presented for informational purposes only and they are not to be construed as warranties or guarantees, express or implied, regarding the products or services described or their use or applicability.

Technical data may be updated; should you require confirmation with respect to a specific value, please contact Emerson Climate Technologies GmbH and clearly state the information you require.

Emerson Climate Technologies GmbH and/or its affiliates (collectively "Emerson") shall not be liable for errors in the stated capacities, dimensions, etc., as well as typographic errors. Products, specifications, designs and technical data contained in this document are subject to modification by us without prior notice. Illustrations are not binding.

Emerson does not assume responsibility for the selection, use or maintenance of any product. Responsibility for proper selection, use and maintenance of any product remains solely with the purchaser and end-user.

The information given herein is based on data and tests which Emerson Climate Technologies GmbH believes to be reliable. Such information is intended for use by individuals having the appropriate technical knowledge and skills, at their own discretion and risk. Our products are designed and adapted for stationary application. When using our products in mobile applications, our products might fail. The suitability for such mobile applications has to be assured by the plant manufacturer; for this purpose, appropriate tests might be necessary.

Section 1: Products for use in Zone 2 according ATEX definition	4
Introduction.....	5
Important considerations.....	5
ATEX Zone 2 Definition	5
Device classification	5
European directives and standard.....	5
Compliance and Marking	6
Electrical Control Valves.....	7
Electronic Expansion Valves EX4-7-... FLR Versions	7
Electronic Expansion Valves EXM/L Series	12
Thermo™-Expansion Valves	16
Thermo™-Expansion Valves Series TIH-... FLR.....	16
Thermo™-Expansion Valves Series TX7-... FLR.....	20
Solenoid Valves	21
Solenoid Valves Series 110RB/200RB...-FLR	21
Pressure Transmitter	25
PT5N-...-FLR Pressure Transmitter	25
Pressure Controls	27
PS4-...ATEX Pressure Switch with fixed setting	27
System Protectors and Moisture Indicators.....	29
Hermetic Liquid Line Filter Driers ADK-... FLR	29
Bi-flow Liquid Line Filter Driers BFK-... FLR	30
Moisture Indicator MIA...-FLR	31
Section 2: Products for non-explosive environment	32
Electronic Controllers	33
EXD-HP1/2 Stand-alone Superheat/Economizer Controller.....	33
EXD-SH1/2 Controller for EX4-7-...-FLR with ModBus Communication Capability.....	35
EC3-P32 / -P33 Superheat Controller & Standard ECD-002.....	40
Oil Management Components	45
Oil Management OM3-020P TraxOil	45

Section 1: Products for Use in Zone 2 According ATEX Definition

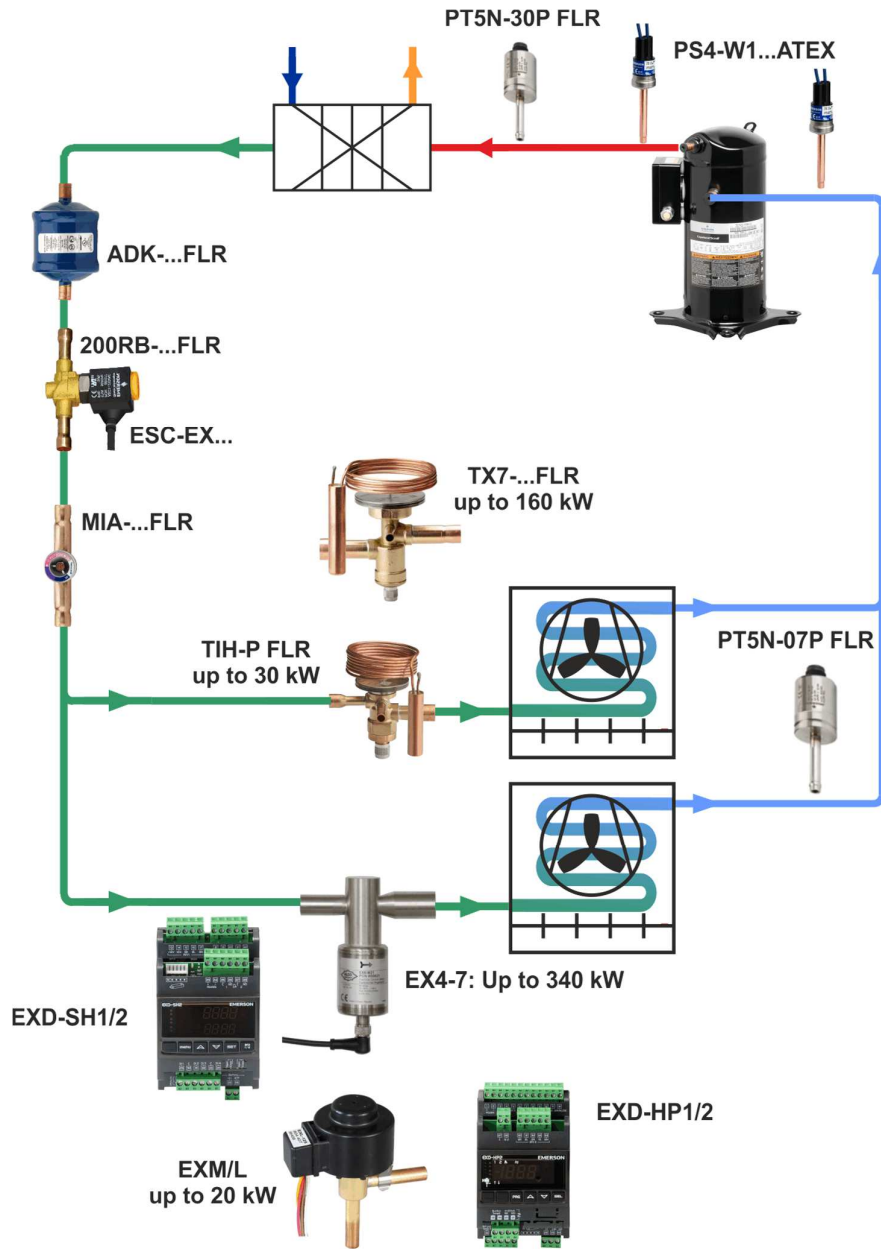

Section 1: Products for Use in Zone 2 According ATEX Definition

Introduction

Many end-users, equipment and compressor manufacturers are investigating ways to minimize their impact on the environment. Improving system architectures and using refrigerants with lower global warming potential (GWP) can significantly improve the carbon footprint of an installation. R290/R1270 are two of most discussed refrigerants in this regard, and they are long been known for their good refrigerating performance, but also for their flammability and, consequently, implying strict considerations for manufacturers related of system design and operation.

Important Considerations

- *The products are intended to be sold in EU and EFTA countries where European directives and standards are in place and considered. Other countries may require additional approval of local authorities/ regulations.*
- *Documentation is in English language. System manufacturers shall consider this fact. If the transmission of information in local language as per requirement of ATEX directive is needed, system manufacturer is to take care of proper translation.*
- *The operating instructions results from risk assessment and it must be taken into account during design and manufacturing of system.*
- *Using inaccurate design operating conditions for selection of products might lead to wrong selection/results. In this case, the selected products might be oversized or undersized and consequently lead to improper operation of the device in the system.*
- *Only specified products in this document have been intended for use with R290/R1270.*
- *It is advisable to share the related information with own consultant or notify body in order to make sure the applicability of products for any specific system under consideration of hazardous zone where system supposed to be operated.*

ATEX Zone 2 Definition

Location of equipment	Category	Explosive atmospheres	Explosive gas	Zone
Group II: Intended for use in other places	3	Unlikely	Gas	2

Device Classification

- Non-electrical operating device without potential of electrostatic charge: (out of scope of ATEX)
 - Thermo™-expansion valves, sight glasses, solenoid valves body (without coil), filter driers
- Electrical operating device contains a housing with sufficient protection design/construction: (in scope of ATEX)
 - Compressor, pressure transmitters, coils of solenoid valves and electronic expansion valves
- Electrical operating device with maximum permitted electrical operating supply voltage/current: (in scope of ATEX)
 - Pressure switches, electronic expansion valves and pressure transmitters
- Electrical operated device approved acc. EN/IEC 60335-2-40/89 (Heat pumps/ refrigeration display cases with limited R290/R1270 charge amount which do not need to comply with ATEX)
 - Electronic expansion valves EXM/L















European Directives and Standard

The following directives and standards have been considered for compliance of products in this document:

- PED (Pressure Equipment Directive)
- ATEX 2014/34/EU (Equipment and protective systems intended for use in potentially explosive atmospheres Directive)
- LVD cannot be used when ATEX is used
- EMC (Electromagnetic Compatibility Directive)
- Guidelines on the application of Directive ATEX 2014/34/EU
- EN60335 (Safety of Household and similar electrical appliance, Part 1 & 40)
- EN60079 (Explosive atmospheres, Part 1, 10-1, 11, 14, 15 and 18)
- EN378 (Refrigerating systems and heat pumps – Safety and environmental requirements)
- EN12284 (Refrigeration systems and heat pumps. Valves: Requirements, testing and marking)
- EN12178 (Refrigeration systems and heat pumps. Liquid level indicating devices: Requirements, testing and marking)
- EN14276-1 (Refrigeration systems and heat pumps. Vessels: Requirements, testing and marking)
- EN12263 (Refrigeration systems and heat pumps. Safety switching devices for limiting pressure: Requirements, testing and marking)
- EN16084 (Refrigeration systems and heat pumps. Qualification of tightness of components and joints)
- EN/IEC 60335-2-40/89 (Electronic expansion valve EXM/L)

Section 1: Products for Use in Zone 2 According ATEX Definition





Compliance and Marking

Product Type		Directive			Standard EN/IEC 60335-2-40/89	Marking
		PED	EMC	ATEX		
Thermo™-expansion valve	TIH-...FLR TX7-...FLR	Out of scope	Out of scope	Out of scope	-	
Electronic expansion valve	EXM/L				Compliance	-
Filter drier	ADK-...-FLR BFK-...-FLR				-	
Sight glass	MIA-...-FLR				-	
Solenoid valve	200RB-...-FLR 110RB-...-FLR				-	
Solenoid coil	ESC-EX	Out of scope	Out of scope	Applicable	-	 CE 
Electronic expansion valve	EX-...-FLR				-	 CE 
Electrical plug and cable assembly	ECV-05A EXV-M60-FLR PT4-M60-FLR				-	 CE 
Pressure transmitter	PT5N-...-FLR		Applicable		-	 CE 
Pressure switch	PS4-...ATEX	Applicable	Out of scope	-	 CE 	

Electronic Expansion Valves EX4-7-...FLR Versions

EMERSON EX4-7-...FLR are stepper motor driven valves for precise control of refrigerant mass flow in air conditioning, refrigeration, heat pumps, close control, and industrial process cooling applications.

Features

- Fully hermetic design
- Stepper motor driven
- Very fast full stroke time
- High resolution and excellent repeatability
- Bi-flow versions with positive shut-off in both flow directions
- Positive shut-off function to eliminate the use of an additional solenoid valve
- Linear flow capacity
- Extremely wide capacity range (10...100%)
- Continuous modulation of mass flow
- Direct coupling of motor and valve for high reliability (no gear mechanism)
- Ceramic slide and port for accurate flow and minimal wear
- Corrosion resistant stainless-steel body and connections
- EX4-7-...FLR:  II 3G Ex nA IIA T3 Gc X
- EVC05A:  II 3G Ex nA IIC Gc
-  II 2D Ex tD IIIC Db IP65/IP67
- EXV-M60 FLR:  II 3G Ex nA IIA T3 Gc U
- The qualification /certification of EX4-7-...FLR is valid only in conjunction with EVC05A / EXV-60 FLR (M12 Connector).



EX4-...FLR



EX7-...FLR

Selection table



Type	Part No.	Flow pattern	Nominal capacity range (kW)		Inlet connection	Outlet connection	Electrical connector
			R290	R1270			
EX4-I21FLR	800430	Uni-flow	2...17	2...19	3/8" ODF	5/8" ODF	Special M12 connector
EX4-M21FLR	800431		2...17	2...19	10 mm ODF	16 mm ODF	
EX5-U21FLR	800432		5...51.6	5...58	5/8" (16 mm) ODF	7/8" (22 mm) ODF	
EX6-I21FLR	800433		12...124	12...139	7/8" ODF	1-1/8" ODF	
EX6-M21FLR	800434		12...124	12...124	22 mm ODF	28 mm ODF	
EX7-I21FLR	800440		30...340	30...383	1-1/8" ODF	1-1/8" ODF	
EX7-M21FLR	800441		30...340	30...383	28 mm ODF	28 mm ODF	
EX4-U31FLR	800435	Bi-flow (Heat pump)	2...17	2...17	5/8" (16 mm) ODF	5/8" (16 mm) ODF	
EX5-U31FLR	800436		5...51.6	5...58	7/8" (22 mm) ODF	7/8" (22 mm) ODF	
EX6-I31FLR	800437		1...124	1...139	1-1/8" ODF	1-1/8" ODF	
EX6-M31FLR	800438		1...124	1...139	28 mm ODF	28 mm ODF	
EX7-I31FLR	800442		30...340	30...383	1-1/8" ODF	1-1/8" ODF	
EX7-M31FLR	800443		30...340	30...383	28 mm ODF	28 mm ODF	

Note1: The valves are delivered without cable/connector assembly (order separately).

Note2: Nominal capacity at +38°C liquid temperature, +4°C evaporating temperature and 1K subcooling. For selection of other operating condition, please use quick selection tables in the next pages.

Note3: When selecting also observe the information in the operating instructions. Available on EMERSON website www.climate.emerson.com/en-gb.

Selection Table Assembly

Type	Part No.	Temperature Range	Length (m)	Connector type to valve	Connector type to driver board or controller	Illustration
EXV-M60 FLR	804666	-50...+70°C	6.0	M12 plug	Loose wires	
EVC05A	800439	-20...+60°C	5.0	M12 plug	Loose wires	

Electronic Expansion Valves EX4-7-...FLR Versions

EX4-7-...-FLR: Quick Selection (included 1.5 bar pressure drop for liquid line components and distributor)

Condensing temperature (°C)	R290 Capacity (kW)												Valve type
	Evaporating temperature (°C)												
	15	10	5	0	-5	-10	-15	-20	-25	-30	-35	-40	
75	15	15	15	15	14	14	14	13	13	12	12	11	EX4-...-FLR
	46	46	45	44	43	42	41	40	38	37	35	34	EX5-...-FLR
	110	110	108	106	104	102	99	96	92	89	85	81	EX6-...-FLR
	304	301	298	293	287	280	272	263	254	244	234	223	EX7-...-FLR
70	16	16	16	16	15	15	15	14	14	14	13	13	EX4-...-FLR
	48	48	48	47	47	46	45	44	42	41	40	38	EX5-...-FLR
	116	116	115	114	112	110	108	105	102	98	95	91	EX6-...-FLR
	319	318	316	313	308	303	296	288	280	271	261	251	EX7-...-FLR
65	16	16	16	16	16	16	16	15	15	15	14	14	EX4-...-FLR
	50	50	50	50	49	48	48	47	45	44	43	42	EX5-...-FLR
	119	120	120	119	118	116	114	112	109	106	103	100	EX6-...-FLR
	327	329	329	327	324	320	314	308	300	292	283	274	EX7-...-FLR
60	16	17	17	17	17	17	16	16	16	15	15	15	EX4-...-FLR
	50	51	51	51	51	50	50	49	48	47	46	44	EX5-...-FLR
	120	121	122	122	122	121	119	117	115	112	109	106	EX6-...-FLR
	329	334	336	336	335	332	327	322	316	309	301	292	EX7-...-FLR
55	16	17	17	17	17	17	17	17	16	16	16	15	EX4-...-FLR
	49	50	51	51	52	51	51	50	50	49	48	46	EX5-...-FLR
	118	121	123	124	124	123	122	121	119	117	114	111	EX6-...-FLR
	325	333	337	340	340	339	336	332	327	321	314	306	EX7-...-FLR
50	16	16	17	17	17	17	17	17	17	16	16	16	EX4-...-FLR
	48	49	51	51	52	52	52	51	51	50	49	48	EX5-...-FLR
	115	119	121	123	124	124	124	123	121	120	117	115	EX6-...-FLR
	316	326	334	338	341	341	340	338	334	329	323	316	EX7-...-FLR
45	15	16	16	17	17	17	17	17	17	17	16	16	EX4-...-FLR
	45	48	49	50	51	51	52	51	51	50	50	49	EX5-...-FLR
	109	114	118	121	123	123	124	123	122	121	119	117	EX6-...-FLR
	299	314	325	332	337	340	340	339	337	333	328	322	EX7-...-FLR
40	14	15	16	16	16	17	17	17	17	17	16	16	EX4-...-FLR
	42	45	47	49	50	51	51	51	51	50	50	49	EX5-...-FLR
	100	107	113	117	120	121	122	122	122	121	120	118	EX6-...-FLR
	275	295	310	321	329	333	336	337	336	333	330	325	EX7-...-FLR
35	12	13	14	15	16	16	16	17	17	17	16	16	EX4-...-FLR
	37	41	44	46	48	49	50	50	50	50	50	49	EX5-...-FLR
	88	98	105	111	115	117	119	120	120	120	119	118	EX6-...-FLR
	242	270	290	305	315	323	328	330	331	330	328	324	EX7-...-FLR
30	10	12	13	14	15	15	16	16	16	16	16	16	EX4-...-FLR
	30	36	40	43	45	47	48	49	49	49	49	49	EX5-...-FLR
	71	85	95	103	108	112	115	116	117	118	117	116	EX6-...-FLR
	196	235	262	282	297	308	315	320	323	323	323	320	EX7-...-FLR
20	0	5	9	11	12	13	14	14	15	15	15	15	EX4-...-FLR
	0	16	26	32	37	40	42	44	45	45	46	46	EX5-...-FLR
	0	39	63	78	88	95	101	104	107	109	110	110	EX6-...-FLR
	0	107	174	214	242	262	277	287	295	299	302	303	EX7-...-FLR

Electronic Expansion Valves EX4-7-...FLR Versions



EX4-7-...-FLR: Quick Selection (included 1.5 bar pressure drop for liquid line components and distributor)

Condensing temperature (°C)	R1270 Capacity (kW)												Valve type
	Evaporating temperature (°C)												
	15	10	5	0	-5	-10	-15	-20	-25	-30	-35	-40	
75	17	17	17	17	16	16	16	15	15	14	14	13	EX4-...-FLR
	51	51	51	50	49	48	47	46	45	43	42	40	EX5-...-FLR
	122	122	121	120	118	116	114	111	108	104	100	97	EX6-...-FLR
	336	336	334	330	325	319	312	304	296	286	276	266	EX7-...-FLR
70	18	18	18	18	18	17	17	17	16	16	15	15	EX4-...-FLR
	54	54	54	54	53	53	52	51	49	48	47	45	EX5-...-FLR
	129	130	130	129	128	126	124	122	119	116	112	109	EX6-...-FLR
	355	357	357	355	352	347	341	334	326	318	309	299	EX7-...-FLR
65	18	19	19	19	19	18	18	18	18	17	17	16	EX4-...-FLR
	55	56	56	56	56	56	55	54	53	52	51	49	EX5-...-FLR
	133	135	135	135	135	133	132	130	127	125	122	118	EX6-...-FLR
	366	370	372	372	370	367	363	357	350	343	334	325	EX7-...-FLR
60	18	19	19	19	19	19	19	19	18	18	18	17	EX4-...-FLR
	56	57	58	58	58	58	57	57	56	55	54	52	EX5-...-FLR
	135	137	138	139	139	139	137	136	134	131	129	126	EX6-...-FLR
	370	377	381	383	383	381	378	373	368	361	354	346	EX7-...-FLR
55	18	19	19	19	19	19	19	19	19	19	18	18	EX4-...-FLR
	56	57	58	59	59	59	59	58	58	57	56	55	EX5-...-FLR
	133	137	139	141	142	142	141	140	138	136	134	131	EX6-...-FLR
	367	376	383	387	389	389	388	385	380	375	369	361	EX7-...-FLR
50	18	18	19	19	20	20	20	20	19	19	19	19	EX4-...-FLR
	54	56	58	59	59	59	59	59	59	58	57	56	EX5-...-FLR
	130	134	138	140	142	143	143	142	141	140	138	135	EX6-...-FLR
	357	370	380	386	391	393	393	391	388	384	378	372	EX7-...-FLR
45	17	18	19	19	19	20	20	20	20	19	19	19	EX4-...-FLR
	51	54	56	58	59	59	60	60	59	59	58	57	EX5-...-FLR
	123	130	135	138	141	142	143	143	142	141	140	138	EX6-...-FLR
	339	357	370	380	387	391	393	393	391	388	384	379	EX7-...-FLR
40	16	17	18	18	19	19	19	20	20	19	19	19	EX4-...-FLR
	48	51	54	56	57	58	59	59	59	59	58	58	EX5-...-FLR
	114	123	129	134	137	140	141	142	142	141	140	139	EX6-...-FLR
	314	337	355	368	378	384	388	390	390	389	386	382	EX7-...-FLR
35	14	15	17	18	18	19	19	19	19	19	19	19	EX4-...-FLR
	42	47	50	53	55	57	58	58	58	58	58	58	EX5-...-FLR
	102	113	121	127	132	136	138	139	140	140	140	139	EX6-...-FLR
	280	310	333	351	364	373	380	384	385	385	384	381	EX7-...-FLR
30	12	14	15	16	17	18	18	19	19	19	19	19	EX4-...-FLR
	35	41	46	49	52	54	55	56	57	57	57	57	EX5-...-FLR
	84	99	110	119	125	130	133	135	137	138	138	137	EX6-...-FLR
	231	273	304	327	344	357	366	373	376	378	378	377	EX7-...-FLR
20		7	11	13	14	15	16	17	17	18	18	18	EX4-...-FLR
		22	32	39	43	47	49	51	52	53	54	54	EX5-...-FLR
		53	77	93	104	112	118	123	126	128	129	130	EX6-...-FLR
		146	212	255	285	308	325	338	346	352	356	358	EX7-...-FLR

Electronic Expansion Valves EX4-7-...FLR Versions

Technical Data EX4-7-...FLR Valves

MOPD (maximum operating pressure differential)	30 bar
Max. allowable working pressure PS	35 bar
Max. system test pressure PT	38.5 bar
Temperatures	
Ambient	-20...+60°C
Storage	-40...+70°C
Medium inlet temperature	
Bi-flow version	TS: -40...+80°C
Uni-flow version	TS: -50...+100°C
Vibration for non-connected and fastened valve	4g (0...1000 Hz, 1 octave /min.)
Material	stainless steel body and fittings



Protection acc. to IEC 529, DIN 40050	IP67 (via EXV-M60 FLR)
Humidity	5...95% r.H.
Connections	ODF stainless steel fittings
Shock	20g at 11 ms 80g at 1 ms
Net weight (kg)	0.5 kg (EX4), 0.52 kg (EX5), 0.60 kg (EX6), 1.1 kg (EX7)
Package and delivery	without electrical connector
Accessories	M12 Connector EXV-M60-FLR
Markings	 acc. to directive 14/34/EU  II 3G Ex nA IIA T3 Gc X

Electrical Data EX4-7-...FLR Valves



Stepper motor type	Bi-polar, phase current by chopper control (constant current)
Electrical connection	4 pin terminal via plug
Nominal supply voltage to the valve U	24 VDC
Driver supply voltage range	18...36 VDC
Phase current, operating	EX4-6-...FLR: 500 mA EX7-...FLR: 750 mA
Holding current	EX4-6-...FLR: 100 mA EX7-...FLR: 250 mA

Step mode	2 phase full step, half step or microstep
Step angle	1.8° per step ± 8%
Stepping rate	500 Hz
Total number of steps	EX4-6-...FLR: 750 full steps EX7-...FLR: 1600 full steps
Winding resistance per phase	EX4-6-...FLR: 14 Ohm ±10% EX7-...FLR: 10 Ohm ±10%
Full travel time	EX4-6-...FLR: 1.5 seconds EX7-...FLR: 3.2 seconds
Reference position	Mechanical stop at fully closed position

Technical Data EXV-M60-FLR

Protection class	IP67
Ambient temperature	-50...+70°C
Design	angled
Marking	 acc. to directive 14/34/EU  II 3G Ex nA IIA T3 Gc U

Technical data EVC05A (ifm electronic GmbH)

Operating voltage	36 VDC in conjunction with EX4-7-...FLR
Current rating	800 mA in conjunction with EX4-7-...FLR
Design	angled
Ambient temperature	-20...+60°C
Approval	BVS 08 ATEX E 109 U IECEX BVS 08.0041 U
Marking	 II 3G Ex nA IIC Gc  II 2D Ex tD IIIC Db IP65/IP67

Material body	housing: TPU orange; sealing: Viton
Material nut	Stainless steel 316L / 1.4404
Protection	IP 67
Tightening torque for knurled nut	1.2...1.5 Nm
Connection	PUR cable / 5 m; 4 x 0.34 mm ² (42 x Ø 0.1 mm); Ø 4.9 mm; halogen-free
Weight	0.18 Kg

Electronic Expansion Valves EX4-7-...FLR Versions

Dimensions EX4-7-...FLR (mm)

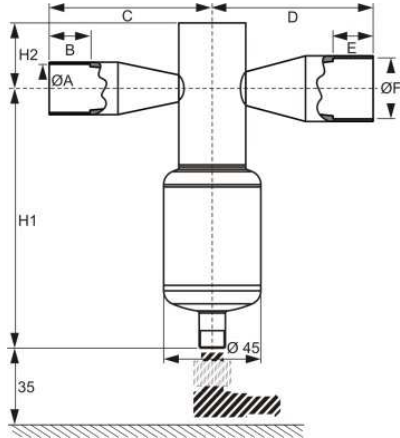

EXV	Flow pattern	Part No.	Ø A x Ø F(ODF)	B	C	D	E	H1	H2
EX4-I21FLR	Uni-flow	800430	3/8" x 5/8"	8	45	55	11	113	25
EX4-M21FLR		800431	10 x 16 mm	8	45	55	11	113	25
EX5-U21FLR		800432	5/8" x 7/8" (16 x 22mm)	11	55	65	16	113	25
EX6-I21FLR		800433	7/8" x 1-1/8"	16	65	75	19	113	25
EX6-M21FLR		800434	22 x 28 mm	16	65	75	19	113	25
EX7-I21FLR		800440	1-1/8" x 1-1/8"	20	78	83	20	158	42
EX7-M21FLR		800441	28 x 28 mm	20	78	83	20	158	42
EX4-U31FLR	Bi-flow	800435	16 x 16 mm (5/8" x 5/8")	11	55	55	11	113	25
EX5-U31FLR		800436	7/8" x 7/8" (22 x 22mm)	16	65	65	16	113	25
EX6-I31FLR		800437	1-1/8" x 1-1/8"	19	75	75	19	113	25
EX6-M31FLR		800438	28 x 28 mm	19	75	75	19	113	25
EX7-I31FLR		800442	1-1/8" x 1-1/8"	20	83	83	20	158	42
EX7-M31FLR		800443	28 x 28 mm	20	83	83	20	158	42

Dimensions (mm)

EXV-M60-FLR

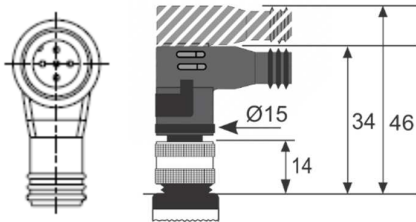

EVC05A

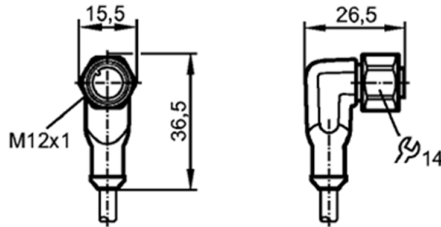

Electronic Expansion Valves EXM/L Series

EXM/EXL Unipolar stepper motor driven Electronic Expansion Valves are for precise control of refrigerant mass flow in heat pumps and self-contained display cases and intended to be used built in a finished product.

The valve is not released for refrigeration applications such as cold room and refrigeration display cabinet.

Compliance with EN/IEC 60335-2-40/89 for heat pumps and display cases with R290 refrigerant. Additional requirements (see operation instructions).

Features

- Hermetic design
- Continuous, linear modulation of mass flow
- Bi-flow with same capacity in normal and reverse flow direction
- High MOPD: 40bar in normal flow direction
- Unipolar stepper motor
- Removable coils in two versions: 12VDC/24VDC
- Fine resolution: 500 pulses (half steps) or 250 full steps
- Protection class of molded coil is IP65 (acc. EN 60529) excluding the cable end terminals (JST).
- Reliability: 225 million pulses at 40 bar differential pressure



EXM/EXL with Coil

Selection Table

Valve Series	Description	Type	Part. No. (10 pcs)	Nominal capacity (kW)	Connections Size / Style
				R290	
EXM	Valve less coil	EXM-B0A	800399M	1.6	1/4" ODM
		EXM-B0B	800400M	4.9	
		EXM-B0D	800401M	10.3	
		EXM-B0E	800402M	12.1	
	Coil 12VDC	EXM-125	800403M	-	-
Coil 24VDC	EXM-24U	800415M	-	-	
EXL	Valve less coil	EXL-B1F	800405M	15.0	1/4" ODF 8 mm ODM
		EXL-B1G	800406M	20.3	
	Coil 12VDC	EXL-125	800407M	-	-
	Coil 24VDC	EXL-24U	800416M	-	-

Note1: Nominal capacities at +38°C condensing temperature, +4 °C evaporating temperature and 1K subcooling. For selection of other operating condition, please use quick selection tables in the next pages.

Note2: When selecting also observe the information in the operating instructions. Available on EMERSON website www.climate.emerson.com/en-gb.

Wiring

EXM-125/EXL-125 (12 VDC, 5 wires coil)

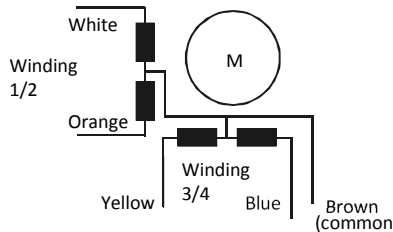

EXM-24U/EXL-24U (24 VDC, 5 wires coil)

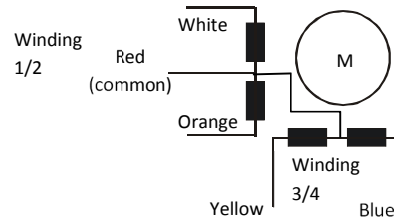

Winding Number	Wire Color	Recommended half step pulsing/switching mode								Remark
		1	2	3	4	5	6	7	8	
1/2	White	ON	ON	OFF	OFF	OFF	OFF	OFF	ON	1) The pulse sequence 1 to 8 will be repeated for further pulses in order to open the valve. 2) The pulse sequence 8 to 1 will be repeated for further pulses in order to close the valve.
	Orange	OFF	OFF	OFF	ON	ON	ON	OFF	OFF	
3/4	Yellow	OFF	ON	ON	ON	OFF	OFF	OFF	OFF	
	Blue	OFF	OFF	OFF	OFF	OFF	ON	ON	ON	
Commons	12V: Brown 24V: Red	ON	ON	ON	ON	ON	ON	ON	ON	

Valve movement mode (pulsing/switching sequence)
Valve open: 1 → 2 → 3 → 4 → 5 → 6 → 7 → 8 Valve close: 8 → 7 → 6 → 5 → 4 → 3 → 2 → 1

Electronic Expansion Valves EXM/L Series

EXM/L: Quick Selection (included 1.5 bar pressure drop for liquid line components and distributor)

Condensing temperature (°C)	R290 Capacity (kW)										Valve type
	Evaporating temperature (°C)										
	15	10	5	0	-5	-10	-15	-20	-25	-30	
70	1.5	1.5	1.5	1.5	1.4	1.4	1.4	1.3	1.3	1.3	EXM-B0A
	4.5	4.5	4.5	4.5	4.4	4.3	4.2	4.1	4	3.9	EXM-B0B
	9.6	9.6	9.5	9.4	9.3	9.1	8.9	8.7	8.4	8.2	EXM-B0D
	11.3	11.3	11.3	11.1	11	10.8	10.5	10.2	10	9.6	EXM-B0E
	14.1	14.1	14	13.8	13.6	13.4	13.1	12.7	12.4	12	EXL-B1F
	19	19	18.9	18.7	18.4	18.1	17.7	17.2	16.7	16.2	EXL-B1G
65	1.5	1.5	1.5	1.5	1.5	1.5	1.5	1.4	1.4	1.4	EXM-B0A
	4.7	4.7	4.7	4.7	4.6	4.6	4.5	4.4	4.3	4.2	EXM-B0B
	9.8	9.9	9.9	9.9	9.8	9.6	9.5	9.3	9	8.8	EXM-B0D
	11.6	11.7	11.7	11.6	11.5	11.4	11.2	10.9	10.7	10.4	EXM-B0E
	14.4	14.5	14.5	14.4	14.3	14.1	13.9	13.6	13.3	12.9	EXL-B1F
	19.5	19.6	19.6	19.5	19.4	19.1	18.8	18.4	17.9	17.4	EXL-B1G
60	1.5	1.6	1.6	1.6	1.6	1.5	1.5	1.5	1.5	1.4	EXM-B0A
	4.7	4.8	4.8	4.8	4.8	4.7	4.7	4.6	4.5	4.4	EXM-B0B
	9.9	10	10.1	10.1	10.1	10	9.9	9.7	9.5	9.3	EXM-B0D
	11.7	11.9	11.9	12	11.9	11.8	11.6	11.5	11.2	11	EXM-B0E
	14.5	14.7	14.8	14.8	14.8	14.6	14.4	14.2	13.9	13.6	EXL-B1F
	19.7	19.9	20.1	20.1	20	19.8	19.5	19.2	18.9	18.4	EXL-B1G
55	1.5	1.6	1.6	1.6	1.6	1.6	1.6	1.6	1.5	1.5	EXM-B0A
	4.6	4.8	4.8	4.9	4.9	4.8	4.8	4.7	4.7	4.6	EXM-B0B
	9.8	10	10.2	10.2	10.2	10.2	10.1	10	9.8	9.7	EXM-B0D
	11.6	11.8	12	12.1	12.1	12	11.9	11.8	11.6	11.4	EXM-B0E
	14.4	14.7	14.9	15	15	15	14.8	14.6	14.4	14.2	EXL-B1F
	19.4	19.9	20.1	20.3	20.3	20.2	20.1	19.8	19.5	19.2	EXL-B1G
50	1.5	1.5	1.6	1.6	1.6	1.6	1.6	1.6	1.6	1.5	EXM-B0A
	4.5	4.7	4.8	4.8	4.9	4.9	4.9	4.8	4.8	4.7	EXM-B0B
	9.5	9.8	10.1	10.2	10.3	10.3	10.2	10.2	10	9.9	EXM-B0D
	11.2	11.6	11.9	12	12.1	12.1	12.1	12	11.9	11.7	EXM-B0E
	13.9	14.4	14.7	14.9	15	15.1	15	14.9	14.7	14.5	EXL-B1F
	18.8	19.5	19.9	20.2	20.4	20.4	20.3	20.2	19.9	19.6	EXL-B1G
45	1.4	1.5	1.5	1.6	1.6	1.6	1.6	1.6	1.6	1.6	EXM-B0A
	4.3	4.5	4.6	4.7	4.8	4.8	4.9	4.8	4.8	4.8	EXM-B0B
	9	9.5	9.8	10	10.2	10.2	10.2	10.2	10.1	10	EXM-B0D
	10.6	11.2	11.6	11.8	12	12.1	12.1	12.1	12	11.8	EXM-B0E
	13.2	13.9	14.3	14.7	14.9	15	15	15	14.9	14.7	EXL-B1F
	17.9	18.7	19.4	19.8	20.1	20.3	20.3	20.2	20.1	19.9	EXL-B1G
40	1.3	1.4	1.5	1.5	1.5	1.6	1.6	1.6	1.6	1.6	EXM-B0A
	3.9	4.2	4.4	4.6	4.7	4.8	4.8	4.8	4.8	4.8	EXM-B0B
	8.3	8.9	9.3	9.7	9.9	10	10.1	10.1	10.1	10	EXM-B0D
	9.8	10.5	11	11.4	11.7	11.9	12	12	11.9	11.9	EXM-B0E
	12.2	13	13.7	14.2	14.5	14.7	14.8	14.9	14.8	14.7	EXL-B1F
	16.4	17.6	18.5	19.2	19.6	19.9	20.1	20.1	20	19.9	EXL-B1G
35	1.1	1.3	1.4	1.4	1.5	1.5	1.5	1.5	1.5	1.5	EXM-B0A
	3.5	3.8	4.1	4.3	4.5	4.6	4.7	4.7	4.7	4.7	EXM-B0B
	7.3	8.1	8.7	9.2	9.5	9.7	9.9	10	10	9.9	EXM-B0D
	8.6	9.6	10.3	10.8	11.2	11.5	11.7	11.8	11.8	11.7	EXM-B0E
	10.7	11.9	12.8	13.4	13.9	14.3	14.5	14.6	14.6	14.6	EXL-B1F
	14.5	16.1	17.3	18.2	18.8	19.3	19.6	19.7	19.8	19.7	EXL-B1G

Electronic Expansion Valves EXM/L Series

Technical Data

MOPD (maximum operating pressure differential)	40 bar in normal flow 33 bar in reverse flow
Max. working pressure PS	45 bar
External leakage	≤ 3 gram / year
Temperature range TS Liquid refrigerant Ambient	-30...+70°C -30...+60°C
Air seat leakage at 10 bar differential pressure	Typically, 150 cm ³ /min.
Relative humidity	95%



Connections, A and B	EXM: ¼" ODM EXL: ¼" ODF and 8 mm ODM
Bi-flow direction Normal: Reverse:	Connection A to B Connection B to A
Valve installation Normal use self-contained display cabinet/unit	Coil upside or to vertical within ±90° Coil upside or to vertical within ±60° (in cold/ wet compartment)
Marking	CE Not required
VDE Test 2017 acc.	EN/IEC-60335-2-89 EN/IEC-60335-2-40
Package and delivery	10 pieces
Weight Valve Coil	EXM: 65 g, EXL: 76 g EXM: 124 g, EXL: 156 g

Endurance

- Continuous 40 bar differential pressure across the valve (In normal flow direction from A to B)
- Cycling between fully close and fully open while 40 bar differential pressure across the valve has been maintained during cycling
- Each cycle consist of:
 - o From 0% to 100% fully open position equal to 500 pulses
 - o From 100% to 0% fully close position equal to 500 pulses
- 225.000 cycles or equal to 225 million pulses

Electrical Data

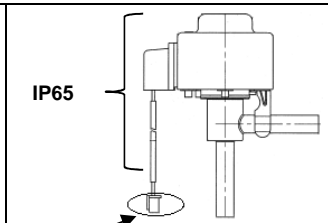
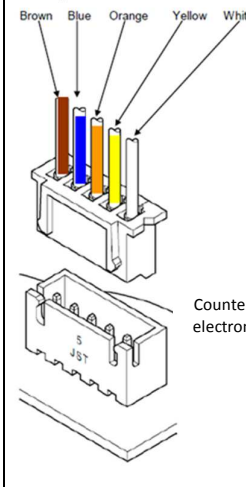
Stepper motor type	Uni-polar, constant voltage
Electrical connection	12 VDC coil : 5 wires 24 VDC coil: 5 wires
Supply voltage	12 VDC coil: 12V ± 10% 24 VDC coil: 24V ± 10%
Phase current, operating	12 VDC coil: 260 mA 24 VDC coil: 130 mA
Winding resistance per phase	12 VDC coil: 46 Ohm 24 VDC coil: 185 Ohm
Insulation resistance	Min. 100 MΩ at 500 VDC
Cable length	1 meter
Step mode	Half step = one pulse
Total number of pulses	500 half step (250 full step)
Pulsing rate	30 to 90 pulses (half step) per sec
Full travel time	16.6 seconds at 30 pulse/sec 5.5 seconds at 90 pulse/sec
Reference position	Mechanical stop at fully close position at 520 pulses
Valve starts to open at:	32 pulses ± 20 pulses
Insulation class	E

Protection class	 <p>IP65</p> <p>JST connector: IP30</p>
Electrical connection Example: EXML-125 JST Plug	 <p>Brown Blue Orange Yellow White</p> <p>Counter plug on electronic board</p>
	<p>JST XH connector Housing: XHP-5 Pin: SXH-001T-P0.6</p> 

Electronic Expansion Valves EXM/L Series

Dimensions (mm)

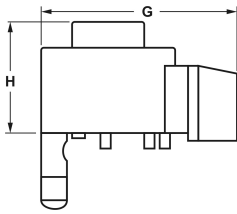

Coil	G (mm)	H (mm)
EXM-...	52.5	32
EXL-...	59	34

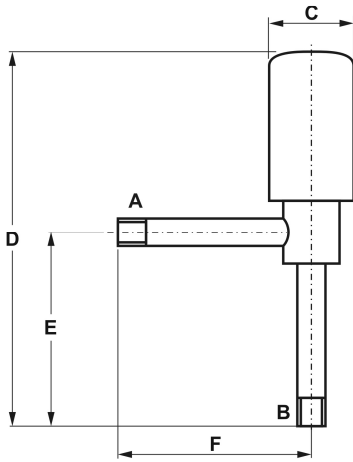

Valve type	A / B Connections		C (mm)	D (mm)	E (mm)	F (mm)
	Diameter	Length (mm)				
EXM-...	1/4" ODM	8	17.3	78	36	36.3
EXL-...	1/4" ODF / 8 mm ODM	8	21.8	90	42	42

Thermo™-Expansion Valves Series TIH-...FLR

TIH-...FLR series of Thermo™-Expansion Valves are designed for air conditioning, heat pumps and commercial refrigeration applications. The TIH-...FLR is ideal for those applications requiring hermetic/ compact size combined with stable and accurate control over wide load and evaporating temperature ranges.

Features

- Compact size and hermetic design
- up to 29.4 kW for R290
- Balanced port design
- Brazing connections (imperial and metric) with straight through configuration
- Stainless steel power element resists corrosion
- Large diaphragm provides smoother and consistent valve control
- Internal or external equalizer
- External superheat adjustment
- Standard with integrated 100 mesh size strainer at inlet of valve
- Packaging with 20 pieces necked including bulb fastening accessories and single operating instruction
- Sample as single package

Options

- Special setting or bleed hole function on request: Minimum order quantity 100 pieces per batch, type and order
- Valve without internal strainer on request: Minimum order quantity 100 pieces per batch, type and order



TIH-P24-FLR

Selection Table R290 (20 pieces)

Capacity (kW) R290	Metric connection				Imperial connection				Connection		
	without MOP		with MOP		without MOP		with MOP		Inlet	Outlet	Equalizer
	Type	Part No.	Type	Part No.	Type	Part No.	Type	Part No.			
3.2	TIH-P02 M FLR	802650M							6 mm	10 mm	internal
3.2					TIH-P02 FLR	802664M			1/4"	3/8"	internal
5.3	TIH-P03 M FLR	802651M							6 mm	10 mm	internal
5.3					TIH-P03 FLR	802665M			1/4"	3/8"	internal
7.5	TIH-P04 M FLR	802652M							10 mm	12 mm	internal
7.5					TIH-P04 FLR	802666M			3/8"	1/2"	internal
3.2	TIH-P22 M FLR	802653M							6 mm	10 mm	6 mm
3.2					TIH-P22 FLR	802667M			1/4"	3/8"	1/4"
5.3	TIH-P23 M FLR	802654M							6 mm	10 mm	6 mm
5.3					TIH-P23 FLR	802668M			1/4"	3/8"	1/4"
7.5	TIH-P24 M FLR	802655M							10 mm	12 mm	6 mm
7.5					TIH-P24 FLR	802669M			3/8"	1/2"	1/4"
11.0	TIH-P25 M FLR	802656M							10 mm	12 mm	6 mm
11.0					TIH-P25 FLR	802670M			3/8"	1/2"	1/4"
12.9	TIH-P26 M FLR	802657M							10 mm	12 mm	6 mm
12.9					TIH-P26 FLR	802671M			3/8"	1/2"	1/4"
18.4	TIH-P27 M FLR	802658M							12 mm	16 mm	6 mm
18.4					TIH-P27 FLR	802672M			1/2"	5/8"	1/4"
20.5	TIH-P28 M FLR	802659M							12 mm	16 mm	6 mm
20.5					TIH-P28 FLR	802673M			1/2"	5/8"	1/4"
23.6	TIH-P29 M FLR	802660M							12 mm	16 mm	6 mm
23.6					TIH-P29 FLR	802674M			1/2"	5/8"	1/4"
29.4	TIH-P2A M FLR	802661M							12 mm	16 mm	6 mm
29.4					TIH-P2A FLR	802675M			1/2"	5/8"	1/4"

Note1: The nominal capacities are based +4°C evaporating temperature, +38°C condensing temperature and 1 K subcooling. For other operating conditions use the quick selection in this document.

Note2: When selecting also observe the information in the operating instructions. Available on EMERSON website www.climate.emerson.com/en-gb.

Superheat

The factory setting of TIH-...FLR is made with the valve pin just starting to move away from seat. The superheat increments necessary to get the pin ready to move is called static superheat (SS). A superheat increments over and beyond the static superheat (factory setting) is necessary for the valve pin to open to its rated capacity. This additional superheat is known as gradient or opening superheat (OS).

The working superheat, which can be measured in field, is the sum of static superheat and opening superheat (WS).

The opening superheat of TXV varies if the selected valve operates at higher or lower capacities than rated capacity. It is highly recommended to select the valve according to the rated capacity. Using reserve capacity leads to larger opening superheat and longer pull-down time during start-up or after defrosting.

Selecting a larger valve than required in system may lead to smaller opening superheat and/or hunting of TXV.

Static Superheat Setting

Thermo®-Expansion Valves are factory preset for optimum superheat settings. This setting should be modified only if absolutely necessary. The readjustment should be at the **lowest** expected evaporating temperature.

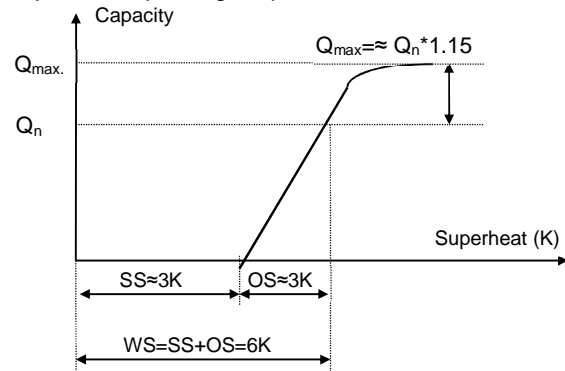

Q_n = Nominal capacity

SS: Static superheat at rated nominal operating condition

OS: Opening superheat at rated nominal capacity

Heat Pump Application

There are several ways to apply an expansion valve in a heat pump. The following figure is showing the most popular application:

Bi-flow application

For application of TIH-...FLR in Bi-flow as single expansion valve in heat pumps, the following subjects need to be considered:

- TIH-...FLR is balanced port only in normal flow direction but not in reverse flow direction.
- Inlet pressure in reverse flow act on valve pin as closing force. This effect is more significant at higher inlet pressure and lower evaporating temperature.
- This effect will prevent the valve from desired opening percentage in reverse flow depends on port size of valve, inlet pressure and evaporating temperature.

Based on the above facts, it is necessary to evaluate the selection of TIH-...FLR in Bi-flow application.

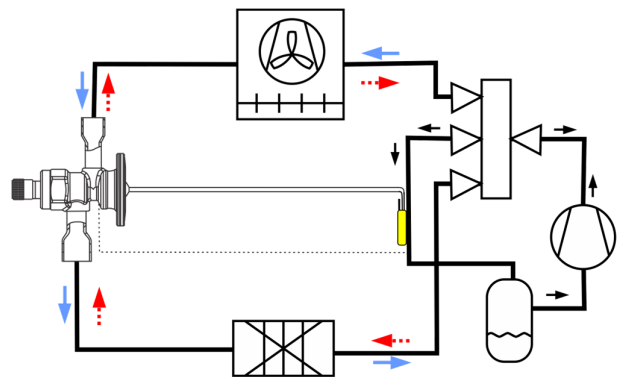

System with single Bi-flow expansion valve and EMERSON suction filter dryer ASD.

Thermo™-Expansion Valves Series TIH-FLR

TIH: Quick Selection (included 1.5 bar pressure drop for liquid line components and distributor)

Condensing temperature (°C)	R290 Capacity (kW)												R290	Valve type
	Evaporating temperature (°C)													
	15	10	5	0	-5	-10	-15	-20	-25	-30	-35	--40		
70	3.0	3.0	3.0	2.9	2.9	2.8	2.5	2.1	1.7	1.4	1.1	0.9	TIH-P...2	
	5.0	5.0	4.9	4.9	4.8	4.7	4.1	3.5	2.8	2.3	1.8	1.4	TIH-P...3	
	7.0	7.0	6.9	6.9	6.8	6.6	5.8	4.9	4.0	3.2	2.5	2.0	TIH-P...4	
	10.3	10.2	10.2	10.1	9.9	9.7	8.5	7.1	5.8	4.7	3.7	3.0	TIH-P...5	
	12.1	12.1	12.0	11.9	11.7	11.5	10.1	8.4	6.9	5.5	4.4	3.5	TIH-P...6	
	17.2	17.2	17.1	16.9	16.7	16.4	14.3	12.0	9.8	7.8	6.2	5.0	TIH-P...7	
	19.2	19.2	19.1	18.9	18.6	18.3	16.0	13.4	10.9	8.7	7.0	5.6	TIH-P...8	
	22.1	22.1	21.9	21.7	21.4	21.0	18.4	15.4	12.5	10.0	8.0	6.4	TIH-P...9	
27.5	27.5	27.3	27.0	26.6	26.1	22.9	19.2	15.6	12.5	10.0	8.0	TIH-P...A		
65	3.1	3.1	3.1	3.1	3.0	3.0	2.6	2.2	1.8	1.5	1.2	0.9	TIH-P...2	
	5.1	5.1	5.1	5.1	5.1	5.0	4.4	3.7	3.0	2.4	2.0	1.6	TIH-P...3	
	7.2	7.2	7.2	7.2	7.1	7.0	6.2	5.2	4.2	3.4	2.7	2.2	TIH-P...4	
	10.5	10.6	10.6	10.5	10.4	10.3	9.1	7.6	6.2	5.0	4.0	3.2	TIH-P...5	
	12.4	12.5	12.5	12.4	12.3	12.1	10.7	9.0	7.4	5.9	4.8	3.8	TIH-P...6	
	17.7	17.8	17.8	17.7	17.5	17.3	15.2	12.8	10.5	8.4	6.8	5.4	TIH-P...7	
	19.7	19.8	19.8	19.7	19.6	19.3	17.0	14.3	11.7	9.4	7.6	6.1	TIH-P...8	
	22.7	22.8	22.8	22.7	22.4	22.1	19.5	16.4	13.4	10.8	8.7	7.0	TIH-P...9	
28.2	28.4	28.4	28.2	28.0	27.6	24.3	20.5	16.7	13.5	10.8	8.7	TIH-P...A		
60	3.1	3.1	3.2	3.2	3.1	3.1	2.8	2.3	1.9	1.5	1.2	1.0	TIH-P...2	
	5.1	5.2	5.3	5.3	5.2	5.2	4.6	3.9	3.2	2.6	2.1	1.7	TIH-P...3	
	7.2	7.3	7.4	7.4	7.3	7.3	6.4	5.4	4.5	3.6	2.9	2.4	TIH-P...4	
	10.6	10.7	10.8	10.8	10.8	10.7	9.4	8.0	6.6	5.3	4.3	3.5	TIH-P...5	
	12.5	12.7	12.8	12.8	12.7	12.6	11.1	9.4	7.7	6.3	5.1	4.1	TIH-P...6	
	17.8	18.0	18.2	18.2	18.1	17.9	15.9	13.4	11.0	8.9	7.2	5.8	TIH-P...7	
	19.9	20.1	20.3	20.3	20.2	20.0	17.7	15.0	12.3	10.0	8.0	6.5	TIH-P...8	
	22.8	23.1	23.3	23.3	23.2	23.0	20.3	17.2	14.1	11.4	9.2	7.4	TIH-P...9	
28.4	28.8	29.0	29.0	28.9	28.6	25.3	21.4	17.6	14.2	11.5	9.3	TIH-P...A		
55	3.1	3.1	3.2	3.2	3.2	3.2	2.8	2.4	2.0	1.6	1.3	1.1	TIH-P...2	
	5.1	5.2	5.3	5.3	5.3	5.3	4.7	4.0	3.3	2.7	2.2	1.8	TIH-P...3	
	7.1	7.3	7.4	7.4	7.4	7.4	6.6	5.6	4.6	3.8	3.0	2.5	TIH-P...4	
	10.5	10.7	10.9	10.9	10.9	10.9	9.7	8.2	6.8	5.5	4.5	3.6	TIH-P...5	
	12.4	12.6	12.8	12.9	12.9	12.9	11.4	9.7	8.0	6.5	5.3	4.3	TIH-P...6	
	17.6	18.0	18.2	18.4	18.4	18.3	16.3	13.8	11.4	9.3	7.5	6.1	TIH-P...7	
	19.6	20.1	20.4	20.5	20.5	20.4	18.2	15.4	12.7	10.3	8.4	6.8	TIH-P...8	
	22.5	23.1	23.4	23.5	23.6	23.5	20.9	17.7	14.6	11.9	9.6	7.8	TIH-P...9	
28.1	28.7	29.1	29.3	29.3	29.2	26.0	22.1	18.2	14.8	12.0	9.7	TIH-P...A		
50	3.0	3.1	3.1	3.2	3.2	3.2	2.9	2.4	2.0	1.6	1.3	1.1	TIH-P...2	
	4.9	5.1	5.2	5.3	5.3	5.3	4.8	4.1	3.4	2.7	2.2	1.8	TIH-P...3	
	6.9	7.1	7.3	7.4	7.5	7.5	6.7	5.7	4.7	3.8	3.1	2.5	TIH-P...4	
	10.2	10.5	10.7	10.9	11.0	11.0	9.8	8.4	6.9	5.7	4.6	3.7	TIH-P...5	
	12.0	12.4	12.7	12.9	12.9	13.0	11.6	9.9	8.2	6.7	5.4	4.4	TIH-P...6	
	17.1	17.6	18.0	18.3	18.4	18.5	16.5	14.1	11.7	9.5	7.7	6.3	TIH-P...7	
	19.0	19.7	20.1	20.4	20.6	20.6	18.4	15.7	13.0	10.6	8.6	7.0	TIH-P...8	
	21.9	22.6	23.1	23.4	23.6	23.6	21.1	18.0	14.9	12.2	9.9	8.0	TIH-P...9	
27.2	28.1	28.8	29.2	29.4	29.4	26.3	22.4	18.6	15.2	12.3	10.0	TIH-P...A		
40	2.3	2.6	2.8	2.9	3.0	3.1	3.1	2.8	2.4	2.0	1.7	1.4	TIH-P...2	
	3.9	4.3	4.6	4.9	5.0	5.1	5.2	4.7	4.1	3.4	2.8	2.3	TIH-P...3	
	5.4	6.0	6.5	6.8	7.0	7.2	7.3	6.6	5.7	4.7	3.9	3.2	TIH-P...4	
	8.0	8.9	9.5	10.0	10.3	10.6	10.7	9.7	8.4	7.0	5.7	4.7	TIH-P...5	
	9.4	10.5	11.2	11.8	12.2	12.5	12.7	11.4	9.9	8.2	6.8	5.5	TIH-P...6	
	13.4	14.9	16.0	16.8	17.4	17.8	18.0	16.3	14.0	11.7	9.6	7.9	TIH-P...7	
	15.0	16.6	17.8	18.7	19.4	19.8	20.1	18.2	15.7	13.1	10.8	8.8	TIH-P...8	
	17.2	19.1	20.5	21.5	22.2	22.8	23.1	20.9	18.0	15.0	12.3	10.1	TIH-P...9	
21.4	23.7	25.5	26.8	27.7	28.3	28.8	26.0	22.4	18.7	15.4	12.6	TIH-P...A		
30	1.3	1.8	2.2	2.5	2.6	2.8	2.9	2.7	2.3	2.0	1.6	1.3	TIH-P...2	
	2.1	3.1	3.7	4.1	4.4	4.6	4.8	4.4	3.9	3.3	2.7	2.2	TIH-P...3	
	3.0	4.3	5.1	5.7	6.2	6.5	6.7	6.2	5.4	4.6	3.8	3.1	TIH-P...4	
	4.4	6.3	7.5	8.4	9.1	9.6	9.9	9.1	7.9	6.7	5.6	4.6	TIH-P...5	
	5.2	7.4	8.9	10.0	10.7	11.3	11.7	10.7	9.4	7.9	6.6	5.4	TIH-P...6	
	7.4	10.6	12.7	14.2	15.3	16.1	16.6	15.3	13.3	11.3	9.4	7.7	TIH-P...7	
	8.2	11.8	14.1	15.8	17.0	17.9	18.6	17.1	14.9	12.6	10.4	8.6	TIH-P...8	
	9.4	13.6	16.2	18.1	19.5	20.6	21.3	19.6	17.1	14.4	12.0	9.9	TIH-P...9	
11.8	16.9	20.2	22.6	24.3	25.6	26.6	24.4	21.3	18.0	14.9	12.3	TIH-P...A		

Thermo™-Expansion Valves Series TIH-FLR

Technical data

Maximum working pressure PS	35 bar
Factory test pressure PT	38.5 bar
Medium temperature range TS	-40...+70°C
Power element	Stainless steel. Laser welded

Connections	Copper ODF
Gross weight	270-305 g (depend on the valve size)
Label	Laser printing

Dimensions (mm)

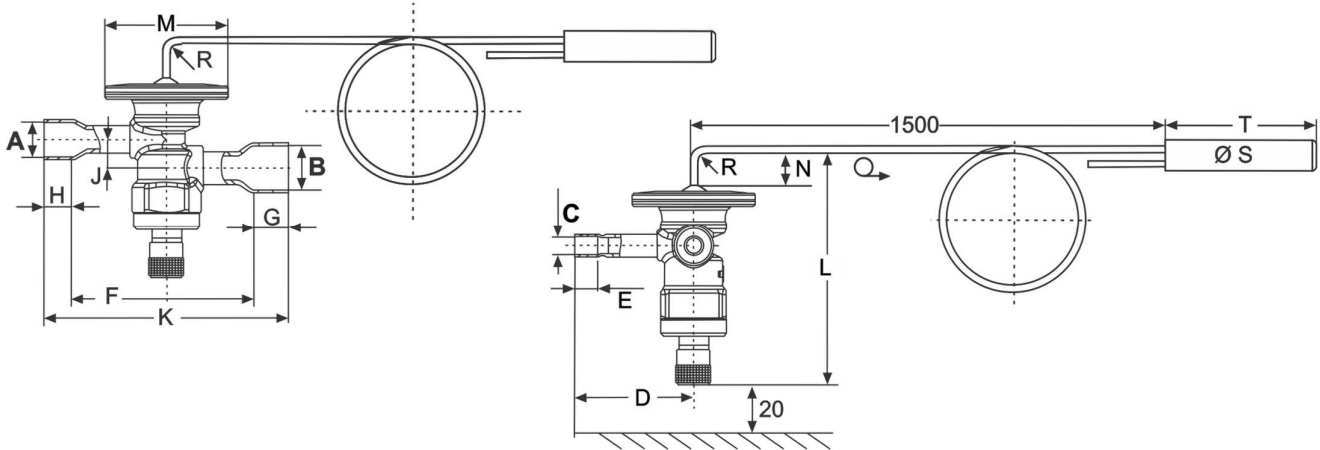

Body:

Type	ODF (mm) / (inch)			(mm)								
	A	B	C	D	E	F	G	H	J	K	L	M
TIH-...2-FLR	6 / 1/4"	10 / 3/8"	internal equalizer	-	-	70.7	8.4	8.4	10.3	87.5	83.2	45
TIH-...3-FLR			6 / 1/4"	43.5	8.4							
TIH-...4-FLR	10 / 3/8"	12 / 1/2"	internal equalizer	-	-	68.7	10.4	8.4	10.3	87.5	83.2	45
TIH-...5-FLR			6 / 1/4"	43.5	8.4							
TIH-...6-FLR	12 / 1/2"	16 / 5/8"	6 / 1/4"			43.5	8.4	64	13.1	10.4	10.3	87.5
TIH-...7-FLR												
TIH-...8-FLR												
TIH-...9-FLR												
TIH-...A-FLR												

Bulb:

Charge	Refrigerant	N	Bending radius R	Ø S	T	Capillary tube length
P0/P2	R290	10 mm	5 mm	13 mm	78 mm	1.5 m

Thermo™-Expansion Valves Series TX7...FLR

TX7 series of Thermo™-Expansion Valves are designed predominantly for AC, heat pumps, close control and industrial process cooling applications. The TX7 is ideal for those applications requiring hermetic / compact size combined with stable and accurate control over wide load and evaporating temperature ranges.

Features

- Monoblock, hermetic valve with brazing connections
- 28 to 160 kW capacity, R290
- Bi-Flow application
 - Balanced port in normal and reverse flow directions eliminates disturbance forces resulting from condensing pressure
 - Optimum static superheat in normal and reverse flow
 - Capacities performance in normal and reverse flow correlates to capacity of heat pumps in cooling and heating mode
- Power Element with 65 mm diameter enables low partial load (20-25%) performance at stable superheat
- Laser welded stainless steel power element with a special diaphragm profile provides life expectancy against high pressure during reversed flow via external equalizer.
- Fine tuning by external superheat adjusting mechanism



TX7-P03-FLR

⚠ Sample order only upon inquiry and agreement. For selection please contact the sales offices.

Dimensions (mm)

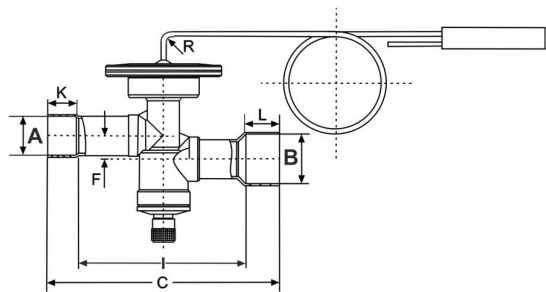

Technical data

Maximum working pressure PS	35 bar
Burst pressure	230 bar
Factory test pressure PT	50.6 bar
Medium temperature range TS	-25...+70°C
Storage temperature	-30...+70°C
Compatibility	R290
Connections	Copper ODF
Capillary tube length	1.5 m
Power elements	Stainless steel, Laser welded
Marking	CE is not required, UL

Size/ Type	Nominal capacity (kw)	Part No.	Inlet *			Outlet *		External equalizer J	Min. overall height (mm) H	Distance between inlet & outlet pipes (mm)		Other (mm)										
			A	B		B				C	E	F	G	K	L	M						
			ODF	ODF		ODF																
TX7-...3-FLR	28		1/2"	5/8"	1/4"			106	109.8	39	13	8	9.1	11.1	8							
TX7-...3M-FLR	28		12mm	16mm	6mm																	
TX7-...4-FLR	35		5/8"	7/8"	1/4"				103													
TX7-...4M-FLR	35		16mm	22mm	6mm																	
TX7-...5-FLR	40		5/8"	7/8"	1/4"			109	95.2	40.5	13	11	15.9	18.9	8							
TX7-...5M-FLR	40		16mm	22mm	6mm																	
TX7-...6-FLR	71		7/8"	1-1/8"	1/4"																	
TX7-...6M-FLR	71		22mm	28mm	6mm																	
TX7-...7-FLR	88		7/8"	1-1/8"	1/4"																	
TX7-...7M-FLR	88		22mm	28mm	6mm																	
TX7-...8-FLR	115		7/8"	1-1/8"	1/4"																	
TX7-...8M-FLR	115		22mm	28mm	6mm																	
TX7-...9-FLR	162		7/8"	1-1/8"	1/4"																	
TX7-...9M-FLR	162		22mm	28mm	6mm																	

Note1: The nominal capacities are based +4°C evaporating temperature, +38°C condensing temperature and 1 K subcooling.

Note2: *) Indication for normal flow direction ***) Min. capillary tube bending height D = 10 mm, Bending radius R = 5 mm

Solenoid Valves Series 110RB/200RB...-FLR

110RB/200RB...-FLR are normally closed solenoid valves for various application duties.

Features

- Normally closed
- Pilot operated requires minimum operating pressure differential
- Compact size
- Extended fittings: No disassembly necessary for brazing
- ATEX compliance coils

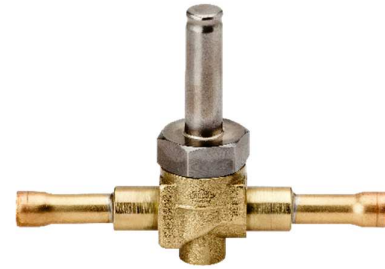

200RB...-FLR

Selection Table Valves

Type	Part No.	Kv-Value (m ³ /h)	Capacity (kW) Liquid line duty		Connections Solder / ODF	
			R290	R1270	(mm)	(inch)
110RB 2T2-FLR	801465	0.2	4.2	4.3	6	
110RB 2T2-FLR	801466					1/4"
110RB 2T3-FLR	801467				10	
200RB 3T3-FLR (mm)	801323	0.4	7.9	8.1	10	
200RB 3T3-FLR	801445					3/8"
200RB 4T10-FLR	801446				10	
200RB 4T4-FLR	801447	0.9	18.7	19.2		1/2"
200RB 4T3-FLR	801448					3/8"
200RB 4T12-FLR	801449				12	
200RB 6T4-FLR	801450	1.6	32.8	33.8		1/2"
200RB 6T12-FLR	801451				12	
200RB 6T5-FLR	801452				16	5/8"

Note1: Nominal capacity at +38°C condensing temperature +4°C evaporating temperature. 1 K subcooling and 0.15 bar pressure drop. For selection of other operating condition, please use quick selection tables in the next pages.

Note2: When selecting also observe the information in the operating instructions. Available on EMERSON website www.climate.emerson.com/en-gb.

Selection Table Coils and Accessory

Type Coils	Part No.	Supply voltage	Power Input	Description	Ambient temperature	Picture
ESC-EX24VAC	801035	24 VAC ±10% 50 Hz	17VA	IP65 acc. EN 60529 test conditions. incl. screw cap with 2x O-ring & fixing retainer	-40...+60°C	
ESC-EX230VAC	801036	230 VAC ±10% 50 Hz	17VA			
ESC-K01	801034	Screw cap (incl. 2x O-ring & fixing retainer)				

Note1: When selecting also observe the information in the operating instructions. Available on EMERSON website www.climate.emerson.com/en-gb.

Solenoid Valves Series 110RB/200RB...-FLR

SOL...-FLR: Quick Selection (0.15 bar pressure drop)

Condensing temperature (°C)	R290 Capacity (kW)												Valve type
	Evaporating temperature (°C)												
	15	10	5	0	-5	-10	-15	-20	-25	-30	-35	-40	
65	2.9	2.9	2.8	2.7	2.6	2.6	2.5	2.4	2.3	2.2	2.2	2.1	110RB2...FLR
	5.5	5.4	5.2	5.1	4.9	4.8	4.6	4.5	4.3	4.2	4.0	3.9	200RB3...FLR
	13.0	12.7	12.4	12.0	11.7	11.3	11.0	10.6	10.2	9.9	9.5	9.2	200RB4...FLR
	22.9	22.3	21.7	21.1	20.5	19.9	19.3	18.6	18.0	17.4	16.7	16.1	200RB6...FLR
60	3.2	3.2	3.1	3.0	2.9	2.8	2.8	2.7	2.6	2.5	2.4	2.3	110RB2...FLR
	6.0	5.9	5.7	5.6	5.4	5.3	5.1	5.0	4.8	4.7	4.5	4.4	200RB3...FLR
	14.3	13.9	13.6	13.2	12.9	12.5	12.2	11.8	11.4	11.1	10.7	10.3	200RB4...FLR
	25.0	24.5	23.9	23.3	22.6	22.0	21.4	20.7	20.1	19.5	18.8	18.1	200RB6...FLR
55	3.5	3.4	3.3	3.3	3.2	3.1	3.0	2.9	2.9	2.8	2.7	2.6	110RB2...FLR
	6.5	6.4	6.3	6.1	6.0	5.8	5.6	5.5	5.3	5.2	5.0	4.9	200RB3...FLR
	15.5	15.1	14.8	14.4	14.1	13.7	13.4	13.0	12.6	12.2	11.9	11.5	200RB4...FLR
	27.2	26.6	26.0	25.4	24.7	24.1	23.5	22.8	22.2	21.5	20.8	20.2	200RB6...FLR
50	3.8	3.7	3.6	3.5	3.5	3.4	3.3	3.2	3.1	3.0	2.9	2.9	110RB2...FLR
	7.0	6.9	6.7	6.6	6.4	6.3	6.1	6.0	5.8	5.7	5.5	5.3	200RB3...FLR
	16.7	16.3	16.0	15.6	15.3	14.9	14.5	14.2	13.8	13.4	13.0	12.6	200RB4...FLR
	29.3	28.7	28.0	27.4	26.8	26.1	25.5	24.8	24.2	23.5	22.9	22.2	200RB6...FLR
45	4.0	4.0	3.9	3.8	3.7	3.6	3.5	3.5	3.4	3.3	3.2	3.1	110RB2...FLR
	7.5	7.4	7.2	7.1	6.9	6.8	6.6	6.5	6.3	6.1	6.0	5.8	200RB3...FLR
	17.8	17.5	17.1	16.8	16.4	16.0	15.7	15.3	14.9	14.5	14.1	13.8	200RB4...FLR
	31.3	30.7	30.1	29.5	28.8	28.2	27.5	26.9	26.2	25.5	24.8	24.2	200RB6...FLR
40	4.3	4.2	4.1	4.1	4.0	3.9	3.8	3.7	3.6	3.5	3.5	3.4	110RB2...FLR
	8.0	7.9	7.7	7.6	7.4	7.3	7.1	6.9	6.8	6.6	6.4	6.3	200RB3...FLR
	19.0	18.6	18.3	17.9	17.5	17.2	16.8	16.4	16.0	15.6	15.3	14.9	200RB4...FLR
	33.3	32.7	32.1	31.5	30.8	30.2	29.5	28.8	28.2	27.5	26.8	26.1	200RB6...FLR
35	4.6	4.5	4.4	4.3	4.2	4.1	4.1	4.0	3.9	3.8	3.7	3.6	110RB2...FLR
	8.5	8.4	8.2	8.0	7.9	7.7	7.6	7.4	7.2	7.1	6.9	6.7	200RB3...FLR
	20.1	19.8	19.4	19.0	18.7	18.3	17.9	17.5	17.1	16.8	16.4	16.0	200RB4...FLR
	35.3	34.7	34.1	33.4	32.8	32.1	31.5	30.8	30.1	29.4	28.7	28.0	200RB6...FLR
30	4.8	4.7	4.6	4.6	4.5	4.4	4.3	4.2	4.1	4.0	3.9	3.9	110RB2...FLR
	9.0	8.8	8.7	8.5	8.4	8.2	8.0	7.9	7.7	7.5	7.4	7.2	200RB3...FLR
	21.2	20.9	20.5	20.2	19.8	19.4	19.0	18.6	18.2	17.8	17.5	17.1	200RB4...FLR
	37.3	36.7	36.0	35.4	34.7	34.1	33.4	32.7	32.0	31.3	30.6	29.9	200RB6...FLR

Note: Select the valve type from tables for capacity value corresponding to system (evaporator) cooling capacity. For other pressure drop than 0.15, please use the below correction factors.

Correction factors $K_{\Delta P}$														
ΔP , bar	0.05	0.1	0.15	0.20	0.25	0.30	0.35	0.40	0.45	0.50	0.55	0.60	0.65	0.70
$K_{\Delta P}$	1.73	1.22	1.0	0.87	0.77	0.71	0.65	0.61	0.58	0.55	0.52	0.50	0.48	0.46

Solenoid Valves Series 110RB/200RB...-FLR

SOL...-FLR: Quick Selection (0.15 bar pressure drop)

Condensing temperature (°C)	R1270 Capacity (kW)												Valve type
	Evaporating temperature (°C)												
	15	10	5	0	-5	-10	-15	-20	-25	-30	-35	-40	
65	3.1	3.0	2.9	2.9	2.8	2.7	2.6	2.6	2.5	2.4	2.3	2.3	110RB2...FLR
	5.7	5.6	5.5	5.3	5.2	5.1	4.9	4.8	4.7	4.5	4.4	4.2	200RB3...FLR
	13.5	13.2	12.9	12.6	12.3	12.0	11.7	11.4	11.0	10.7	10.4	10.0	200RB4...FLR
	23.7	23.2	22.7	22.2	21.7	21.1	20.6	20.0	19.4	18.8	18.2	17.6	200RB6...FLR
60	3.3	3.3	3.2	3.2	3.1	3.0	2.9	2.9	2.8	2.7	2.6	2.5	110RB2...FLR
	6.3	6.1	6.0	5.9	5.8	5.6	5.5	5.3	5.2	5.1	4.9	4.8	200RB3...FLR
	14.8	14.5	14.2	13.9	13.6	13.3	13.0	12.7	12.3	12.0	11.6	11.3	200RB4...FLR
	26.0	25.5	25.0	24.5	23.9	23.4	22.8	22.2	21.6	21.0	20.4	19.8	200RB6...FLR
55	3.6	3.6	3.5	3.4	3.4	3.3	3.2	3.1	3.1	3.0	2.9	2.8	110RB2...FLR
	6.8	6.7	6.5	6.4	6.3	6.1	6.0	5.9	5.7	5.6	5.4	5.3	200RB3...FLR
	16.1	15.8	15.5	15.2	14.9	14.5	14.2	13.9	13.5	13.2	12.8	12.5	200RB4...FLR
	28.2	27.7	27.2	26.7	26.1	25.5	25.0	24.4	23.8	23.2	22.6	21.9	200RB6...FLR
50	3.9	3.8	3.8	3.7	3.6	3.6	3.5	3.4	3.3	3.3	3.2	3.1	110RB2...FLR
	7.3	7.2	7.1	6.9	6.8	6.7	6.5	6.4	6.2	6.1	5.9	5.8	200RB3...FLR
	17.3	17.0	16.7	16.4	16.1	15.8	15.4	15.1	14.7	14.4	14.0	13.7	200RB4...FLR
	30.4	29.9	29.3	28.8	28.2	27.7	27.1	26.5	25.9	25.3	24.6	24.0	200RB6...FLR
45	4.2	4.1	4.1	4.0	3.9	3.8	3.8	3.7	3.6	3.5	3.4	3.4	110RB2...FLR
	7.8	7.7	7.6	7.4	7.3	7.2	7.0	6.9	6.7	6.6	6.4	6.3	200RB3...FLR
	18.5	18.2	17.9	17.6	17.3	16.9	16.6	16.3	15.9	15.6	15.2	14.8	200RB4...FLR
	32.5	32.0	31.4	30.9	30.3	29.8	29.2	28.6	27.9	27.3	26.7	26.0	200RB6...FLR
40	4.5	4.4	4.3	4.2	4.2	4.1	4.0	3.9	3.9	3.8	3.7	3.6	110RB2...FLR
	8.3	8.2	8.1	7.9	7.8	7.7	7.5	7.4	7.2	7.1	6.9	6.8	200RB3...FLR
	19.7	19.4	19.1	18.8	18.4	18.1	17.8	17.4	17.1	16.7	16.3	16.0	200RB4...FLR
	34.6	34.1	33.5	33.0	32.4	31.8	31.2	30.6	30.0	29.3	28.7	28.1	200RB6...FLR
35	4.7	4.7	4.6	4.5	4.4	4.4	4.3	4.2	4.1	4.0	4.0	3.9	110RB2...FLR
	8.8	8.7	8.6	8.4	8.3	8.1	8.0	7.8	7.7	7.5	7.4	7.2	200RB3...FLR
	20.9	20.6	20.3	19.9	19.6	19.3	18.9	18.6	18.2	17.9	17.5	17.1	200RB4...FLR
	36.6	36.1	35.6	35.0	34.4	33.8	33.2	32.6	32.0	31.3	30.7	30.0	200RB6...FLR
30	5.0	4.9	4.8	4.8	4.7	4.6	4.5	4.5	4.4	4.3	4.2	4.1	110RB2...FLR
	9.3	9.2	9.0	8.9	8.8	8.6	8.5	8.3	8.2	8.0	7.9	7.7	200RB3...FLR
	22.0	21.7	21.4	21.1	20.8	20.4	20.1	19.7	19.3	19.0	18.6	18.2	200RB4...FLR
	38.7	38.1	37.6	37.0	36.4	35.8	35.2	34.6	34.0	33.3	32.7	32.0	200RB6...FLR

Note: Select the valve type from tables for capacity value corresponding to system (evaporator) cooling capacity. For other pressure drop than 0.15, please use the below correction factors.

Correction factors $K_{\Delta P}$														
ΔP . bar	0.05	0.1	0.15	0.20	0.25	0.30	0.35	0.40	0.45	0.50	0.55	0.60	0.65	0.70
$K_{\Delta P}$	1.73	1.22	1.0	0.87	0.77	0.71	0.65	0.61	0.58	0.55	0.52	0.50	0.48	0.46

Solenoid Valves Series 110RB/200RB...-FLR

Technical Data Valve

Max. allowable working pressure PS	31 bar
Test pressure PT	34.1 bar

Max. ambient temperature:	-40...+50°C
Operating Temperature Range TS	-40...+120°C

Technical Data ESC-EX... Coil

Supply voltage ESC EX24VAC ESC EX230VAC	24VAC ±10% 230VAC ±10%
Frequency	50 Hz
Vibration resistance	0.7g 10 ... 200 Hz
Protection Class	IP65

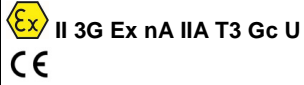
Ambient temperature range	-40...+60°C
Marking	

Dimensions (mm)

110RB...-FLR

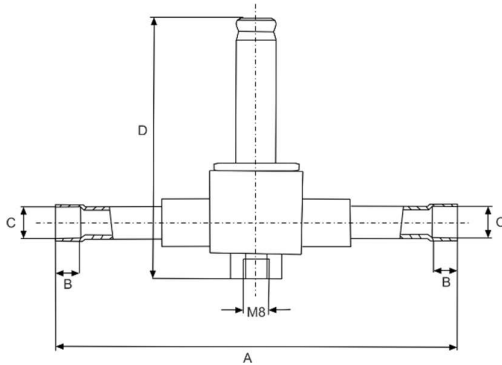

200RB...-FLR

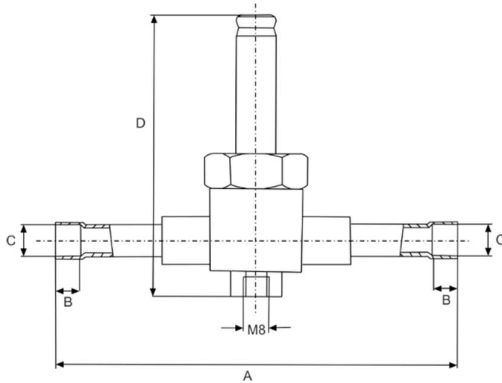

Type	Part No.	(mm)			C	
		A	B	D	Connections Solder / ODF (mm)	(inch)
110RB 2T2-FLR	801465	126	8	77.3	6	
110RB 2T2-FLR	801466		8	77.3		14"
110RB 2T3-FLR	801467		8	77.3	10	
200RB 3T3-FLR (mm)	801323	126	8	88.3	10	
200RB 3T3-FLR	801445		8	88.3		3/8"
200RB 4T10-FLR	801446	126	8	88.3	10	
200RB 4T4-FLR	801447		10	88.3		1/2"
200RB 4T3-FLR	801448		8	88.3		3/8"
200RB 4T12-FLR	801449		10	88.3	12	
200RB 6T4-FLR	801450	126	10	88.3		1/2"
200RB 6T12-FLR	801451		10	88.3	12	
200RB 6T5-FLR	801452		13	88.3	16	5/8"

ESC-EX24VAC / ESC-EX230VAC-ATEX

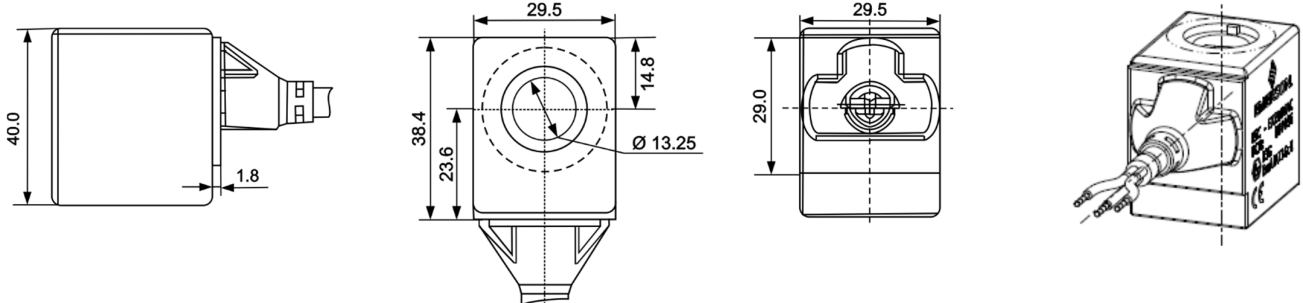

PT5N-...-FLR Pressure Transmitter

PT5N-...-FLR converts a pressure into a linear electrical output signal and is intended for use in hydrocarbons operated air conditioning and refrigeration systems as well as heat pumps.

The pressure transmitter can only be used in hazardous area defined by zone 2 (category 3).

PT5N-...-FLR :  II 3 G
Ex ec IIC T4 Gc

PT4-M60-FLR:  II 3 G
Ex nA IIA T4 Gc U

Features

- Hybrid film stainless steel measuring cell with a diaphragm. installed in a stainless steel housing
- With output signal 4...20 mA and 2-wire connection for the precise operation of superheat, compressor or fan control systems
- Calibrated for specific temperature and pressure ranges
- Calibrated pressure ranges with $\pm 1\%$ accuracy performance
- Fully hermetic
- Vibration, shock and pulsation resistant
- Protection class IP67 with mounted plug and cable assembly
- PT5N-xxP-FLR with 6x40 mm stainless steel tube and integrated brazing neck for easy mounting in applications requiring a fully hermetic system solution.
- Easy install M12 electrical connection with pre-assembled cable assembly available.



PT5N-...P-FLR

Selection Table Pressure Transmitter

Type	Part No.		Pressure range for signal output (bar)*	Output signal	Medium temperature range	Max. working pressure PS (bar)*	Pressure Connection
	Single pack	Multipack 25 pcs					
PT5N-07P-FLR	805390	805390M	-0.8...7	4...20mA	-30...+120°C	27	6 mm tube x 40 mm long
PT5N-30P-FLR	805389	805389M	0...30			60	

Note1: *) Sealed gauge pressure

Note2: When selecting also observe the information in the operating instructions. Available on EMERSON website www.climate.emerson.com/en-gb

Selection Table Cable Assembly

Type	Part No. Single pack	Cable Length**	Temperature Range
PT4-M60 FLR	804806	6.0 m	-40...+70°C

Note: **) Longer length of the electrical connection cable beyond 6.0 m must be verified by user in term of output signal as well as EMC within The qualification /certification of PT5N-...P-FLR is valid only in conjunction with PT4-M60-FLR connector.

PT5N-...-FLR Pressure Transmitter

Technical Data PT5N-...-FLR

Supply voltage (polarity protected)	Nominal: 24VDC Range: 10...30VDC
Operating current circuit ⚠ Applicable Driver/controller must contain intrinsically-safe resistive circuit and insured maximum supply voltage below 30VDC and maximum current below 100 mA.	Maximum ≤ 23 mA 4...20 mA output U _i ≤ 30 V, I _i ≤ 100 mA, P _i ≤ 750mW internal inductance L _i = 0 nH internal capacitance C _i = 0 nF
Load resistance	$R_L \leq \frac{U_b - 7.0V}{0.02A}$
Response time	≤ 2 ms
Vibration at 15...2000Hz	20 g acc. to IEC 60068-2-6
Temperatures Transport and storage Operating ambient housing Medium	-50...+100°C -25...+85°C -30...+120°C

Electrical connection	via PT4-M60-FLR plug and cable assembly
Medium compatibility	All flammable refrigerants of A3 group; mineral-, alkyl benzene and ester lubricants
Protection class (EN60529)	IP67 (PT4-M60 FLR)
Materials Housing pressure connection	Stainless steel 1.4404 / AISI316L Stainless steel 1.4301 / AISI 304
Weight	PT5N-xxP-FLR: ~ 103 g
Markings	<p>CE</p> <p>2014/34/EU: EN 60079-0:12 + A11:13 EN 60079-11: 12 EN 60079-26: 15</p> <p>2014/30/EU: EN 61326-2-3. EN 50121-3-2</p> <p>ATEX  II 3 G Ex ec IIC T4 Gc</p>

Accuracy Performance

Type	Total error ¹	Temperature range
PT5N-07P-FLR	≤ ±1% FS	-30...+20°C
PT5N-30P-FLR	≤ ±1% FS	+10...+50°C
	≤ ±2% FS	-10...+80°C

Note:

¹) Total error includes non-linearity, hysteresis, repeatability as well as offset and span drift due to the temperature changes.

%FS is related to **P**ercentage of **F**ull **S**cale.

Technical Data PT4-M60 FLR

Operating voltage	30 VDC
Protection class	IP65
Ambient temperature	-40...+70°C

Design	angled
Marking	 II 3 G Ex nA IIA T4 Gc U

Dimensions (mm)

PT5N-xxP-FLR

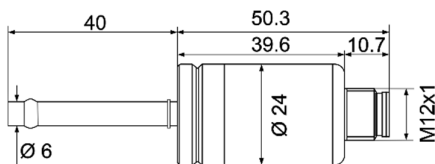

Date of manufacture visible on PT5N-...P-FLR label

YYMMDD-XXX-XX-XXXX

Date (year-month-day) →

3 digits of the order number →

Order position →

Single part number →

PT4-M60 FLR M12 Plug

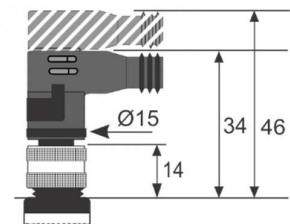

PS4...ATEX Pressure Switch with fixed setting

Features

- High- and low-pressure switches
- With molded cable
- Protection IP67
- TÜV approved
- Minimum lot size for multipack 100 pieces
- Other settings are not available

Marking

-  ENEC05 and CE0035 according to PED
-  II 3G Ex nA IIA T2Gc U



PS4...ATEX

Selection Table



Type	Part No.	Setting (bar)		EN 12263	Contact function	Application	Pressure connection
		Cut-out	Cut-in				
Low pressure switches with automatic reset; Open on falling pressure							
PS4-W1-0.2/1.4 bar ATEX	808306	0.2	1.4	PSL	open on falling pressure	low pressure	6 mm
	808308*						
PS4-W1 0.6/1.8 bar ATEX	808301	0.6	1.8	PSL	open on falling pressure	low pressure	6 mm
	808303*						
High pressure switches with automatic reset; open on rising pressure							
PS4-W1 18/24 bar ATEX	808304*	18	24	PSH	open on rising pressure	high pressure	6 mm
	808305						
PS4-W1 20/26 bar ATEX	808300	20	26	PSH	open on rising pressure	high pressure	6 mm
	808302*						

Note1: *) Single pack

Note2: When selecting also observe the information in the operating instructions. Available on EMERSON website www.climate.emerson.com/en-gb.

Technical Data

Max. allowable working pressure PS	
PS4-W1-0.2/1.4 bar ATEX	22.7 bar
PS4-W1 0.6/1.8 bar ATEX	22.7 bar
PS4-W1 18/24 bar ATEX	37 bar
PS4-W1 20/26 bar ATEX	37 bar
Test pressure PT	
PS4-W1-0.2/1.4 bar ATEX	25 bar
PS4-W1 0.6/1.8 bar ATEX	25 bar
PS4-W1 18/24 bar ATEX	41 bar
PS4-W1 20/26 bar ATEX	41 bar
Electrical rating	50 mA max. at 24VDC
Protection class (EN60259)	IP67
Vibration resistance	4 g (10...250Hz)
Electrical connection	
Cable version	18 AWG 0.8 mm ² . 600 V (max. 125°C)
Cable color	LP: (blue) HP: (black)

Type of electrical contact	Single pole single throw (SPST)
Temperature range	
Medium	-35...+135°C
Ambient	-30...+65°C
Storage	-30...+80°C
Compatibility	R290, R1270
Cable length	3 m
Marking	 ENEC05 and CE0035 acc. PED  II 3G Ex nA IIA T2Gc U



It is mandatory to protect pressure switch against supply voltage higher than 30 VDC and operating current over 50 mA at any time.

PS4...ATEX Pressure Switch with fixed setting

Pressure Setting (Cut-out) Drifting:

PS4...ATEX factory setting is at 23°C room temperature however, the setting will drift by other ambient and fluid temperatures. The table indicates the amount of drift in function of ambient and media temperature.

**PS4 safety pressure cut-out
Braze connection**

Media temp. (°C)	Ambient temperature (°C)									
	0	10	23	25	30	35	40	45	50	55
	Total drift of cut-out set point (%)									
80	+5	+2,8	*	*	*	*	-3.7	-4.8	-5.9	-7.0
85	+5	+2,8	*	*	*	*	-3.8	-4.9	-6.0	-7.1
90	+5	+2,8	*	*	*	*	-3.9	-5.0	-6.1	-7.2
95	+5	+2,8	*	*	*	*	-4.0	-5.1	-6.2	-7.3
100	+5	+2,8	*	*	*	*	-4.1	-5.2	-6.3	-7.4
105	+5	+2,8	*	*	*	-3.1	-4.2	-5.3	-6.4	-7.5
110	+5	+2,8	*	*	*	-3.2	-4.3	-5.4	-6.5	-7.6
115	+5	+2,8	*	*	*	-3.3	-4.4	-5.5	-6.5	-7.6
120	+5	+2,8	*	*	*	-3.4	-4.5	-5.5	-6.6	-7.7
125	+5	+2,8	*	*	*	-3.4	-4.5	-5.6	-6.7	-7.8
130	+5	+2,8	*	*	*	-3.5	-4.6	-5.7	-6.8	-7.9
135	+5	+2,8	*	*	*	-3.6	-4.7	-5.8	-6.9	-8.0

**PS4 safety pressure cut-out
Thread connection**

Media temp. (°C)	Ambient temperature (°C)									
	0	0	23	25	30	35	40	45	50	55
	Total drift of cut-out set point (%)									
80	+5	+2,8	*	*	*	*	-3.7	-4.8	-5.9	-7.0
85	+5	+2,8	*	*	*	*	-3.9	-5.0	-6.1	-7.2
90	+5	+2,8	*	*	*	*	-4.1	-5.2	-6.3	-7.4
95	+5	+2,8	*	*	*	-3.2	-4.3	-5.4	-6.5	-7.6
100	+5	+2,8	*	*	*	-3.4	-4.5	-5.6	-6.7	-7.8
105	+5	+2,8	*	*	*	-3.6	-4.7	-5.8	-6.9	-8.0
110	+5	+2,8	*	*	*	-3.8	-4.9	-6.0	-7.1	-
115	+5	+2,8	*	*	*	-4.0	-5.1	-6.2	-7.3	-
120	+5	+2,8	*	*	-3.2	-4.2	-5.3	-6.4	-7.5	-
125	+5	+2,8	*	*	-3.4	-4.5	-5.5	-6.6	-7.7	-
130	+5	+2,8	*	*	-3.6	-4.7	-5.7	-6.8	-7.9	-
135	+5	+2,8	*	*	-3.8	-4.9	-6.0	-7.0	-	-

Note: European standard for high safety pressure switches permits maximum +0% / -8% of the setting at extreme operating conditions.

*) The device will cut-out anywhere from 0 to -3% from the cut-out.

For low pressure switches with settings between 0 to 6.9 bar:

- type approval, version (W) according to EN 12263: -0 / +1 bar
- standard version (A) according to EN 12263 -0.5 / +0.5 bar

Dimensions (mm)

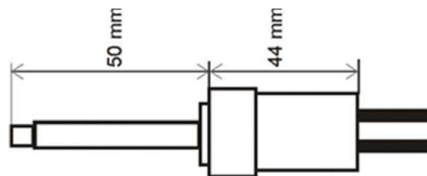

Hermetic Liquid Line Filter Driers ADK-...FLR

ADK-...FLR filter-driers are used for protection of systems against contaminant.

Features

- Solid block
- Hermetic design
- Rugged steel shells
- Corrosion resistant epoxy paint
- Cushioned flow for non-turbulent performance
- High water adsorption capacity
- High acid adsorption capacity
- High filtration capacity / efficiency
- Max. working pressure PS: 35 bar



ADK-...FLR

Selection Table

Type	Part No.	Connection ODF	Flow capacity (kW)	
			Pressure drop R290 0.07bar	R1270 0.07bar
ADK-032S FLR	803650	1/4"	9.6	10
ADK-036MMS FLR	803651	6 mm	8.8	9.1
ADK-052S FLR	803652	1/4"	11.8	12.3
ADK-056MMS FLR	803653	6 mm	10.9	11.4
ADK-053S FLR	803654	3/8"	17.9	18.6
ADK-0510MMS FLR	804066	10 mm	17.9	18.6
ADK-082S FLR	804067	1/4"	13.1	13.6
ADK-086MMS FLR	804068	6 mm	11.7	12.2
ADK-083S FLR	804069	3/8"	18.0	18.7
ADK-0810MMS FLR	804070	10 mm	18.0	18.7
ADK-084S FLR	804071	1/2"	29.3	30.5
ADK-0812MMS FLR	804072	12 mm	28.8	30
ADK-163S FLR	804073	3/8"	20.5	21.3
ADK-1610MMS	804074	10 mm	20.5	21.3
ADK-164S FLR	804075	1/2"	39.4	41.0
ADK-1612MMS FLR	804076	12 mm	35.4	36.8
ADK-165S FLR	804077	5/8" / 16 mm	54.4	56.7
ADK-304S FLR	804078	1/2"	39.5	41.4
ADK-305S FLR	804079	5/8" / 16 mm	57.8	60.2
ADK-307S FLR	804080	7/8" / 22 mm	72.6	75.5
ADK-417S FLR	804081	5/8" / 16 mm	85.3	88.8
ADK-757S FLR	804082	7/8" / 22 mm	115.5	120.3

Technical Data

Max. working pressure PS	35 bar
Test pressure PT	38.5 bar
Temperature range Medium / Ambient	-45...+65°C
Fluid group	I
Solder connections	Copper ODF
Shell	Steel
Paint	Epoxy powder paint
Protection	500+ hours salt spray test
Package	Individual packaged
Standards	EN 14276-1

Note: When selecting also observe the information in the operating instructions. Available on website www.climate.emerson.com/en-gb.

Dimensions (mm)

Type	Connection ODF	(mm)		Type	Connection ODF	(mm)	
		A	Ø F			A	Ø F
ADK-032S-FLR	1/4"	70.1	44.0	ADK-0812MMS-FLR	12 mm	102.6	63.5
ADK-036MMS-FLR	6 mm	70.1	44.0	ADK-163S-FLR	3/8"	126.6	63.5
ADK-052S-FLR	1/4"	85.3	63.5	ADK-1610MMS-FLR	10 mm	126.6	63.5
ADK-056MMS-FLR	6 mm	85.3	63.5	ADK-164S-FLR	1/2"	127.0	63.5
ADK-053S-FLR	3/8"	84.8	63.5	ADK-1612MMS-FLR	12 mm	127.0	63.5
ADK-0510MMS-FLR	10 mm	84.8	63.5	ADK-165S-FLR	5/8" / 16 mm	127.6	63.5
ADK-082S-FLR	1/4"	102.7	63.5	ADK-304S-FLR	1/2"	193.6	76.2
ADK-086MMS-FLR	6 mm	102.6	63.5	ADK-305S-FLR	5/8" / 16 mm	194.2	76.2
ADK-083S-FLR	3/8"	102.1	63.5	ADK-307S-FLR	7/8" / 22 mm	193.6	76.2
ADK-0810MMS-FLR	10 mm	102.1	63.5	ADK-417S-FLR	5/8" / 16 mm	199.9	88.9
ADK-084S-FLR	1/2"	102.5	63.5	ADK-757S-FLR	7/8" / 22 mm	337.4	88.9

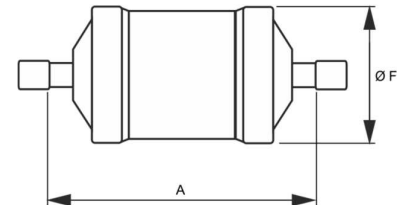

Bi-flow Liquid Line Filter Driers BFK-...FLR

BFK-...FLR filter-driers are used for protection of systems against contaminant.

Features

- Solid block
- Hermetic design
- Rugged steel shells
- Corrosion resistant epoxy paint
- Cushioned flow for non-turbulent performance
- High water adsorption capacity
- High acid adsorption capacity
- High filtration capacity / efficiency
- No CE marking according art. 4.3 PED
- Max. working pressure PS: 35 bar



BFK-...FLR

Selection Table

Type	Part No.	Connection size & Type	Flow capacity (kW)	
			Pressure drop R290 0.07bar	Pressure drop R1270 0.07bar
BFK-052S-FLR	*	1/4" ODF	8.1	8.3
BFK-083S-FLR	*	3/8" ODF	14.4	14.9
BFK-163S-FLR	*	3/8" ODF	18.6	19.3
BFK-084S-FLR	*	1/2" ODF	18.7	19.4
BFK-164S-FLR	*	1/2" ODF	29.1	30.2
BFK-165S-FLR	*	5/8" ODF	30.8	31.9
BFK-305S-FLR	*	5/8" / 16 mm ODF	41.0	42.5
BFK-307S-FLR	*	7/8" / 22 mm ODF	48.7	50.5
BFK-309S FLR	804090	1 1/8" ODF	56.5	58.5

Note2: *) Order upon request and agreement. Delivery after Part No. setup.

Technical Data

Max. working pressure PS	45 bar
Test pressure PT	46.9 bar
Temperature range Medium / Ambient	-30...+65°C
Fluid group	I
Solder connections	Copper ODF
Shell	Steel
Paint	Epoxy powder paint
Protection	500+ hours salt spray test
Package	Individual packaged
Standards	EN 14276-1
Marking	HP

Note1: When selecting also observe the information in the operating instructions. Available on website www.climate.emerson.com/en-gb.

Dimensions

Type	Connection size & type	(mm)		F
		A	B	
BFK-052S	1/4" ODF	106	9.5	64
BFK-083S	3/8" ODF	134	11	
BFK-084S	1/2" ODF	136	12.7	
BFK-163S	3/8" ODF	155	11	76
BFK-164S	1/2" ODF	156	12.7	
BFK-165S	5/8" ODF	163	16	
BFK-305S	5/8" ODF	236	16	
BFK-307S	7/8" ODF	251	19	
BFK-309S	1-1/8" ODF	251	24	

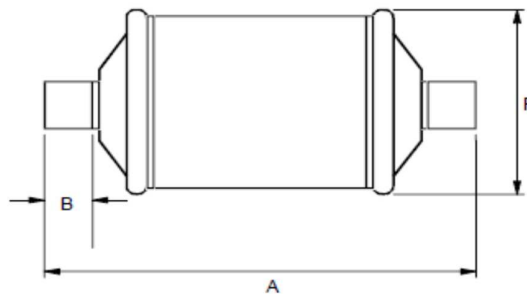

Moisture Indicator MIA...-FLR

Features

- Fully hermetic
- Lower Pressure drop
- Corrosion free stainless-steel body
- Crystal Indicator element for long lifetime and reliability
- Easily determination of moisture content
- Sensitive indicator with calibrated four colors. Conforms to requirement of most compressor manufacturers
- Large clear viewing area
- ODF extended tube configurations suitable for all commercial applications



**MIA
Moisture Indicator**

Selection Table and Dimensions

Type	Part No.	For tube outside diameter	Height A (mm)	Length B (mm)	Weight (g)
MIA 014-FLR	805895	1/4"	25.7	98.0	60
MIA 038-FLR	805896	3/8"	28.5	109.0	70
MIA 012-FLR	805897	1/2"	31.8	113.0	75
MIA 058-FLR	805898	5/8"	31.8	108.5	85
MIA 078-FLR	805899	7/8"	37.8	122.5	150
MIA 118-FLR	805900	1 1/8"	43.5	122.5	190

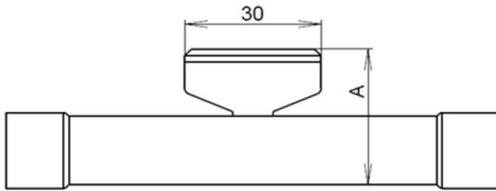

Type	Part No.	For tube outside diameter	Height A (mm)	Length B (mm)	Weight (g)
MIA M06-FLR	805901	6 mm	25.9	98.0	60
MIA M10-FLR	805894	10 mm	28.5	109.0	70
MIA M12-FLR	805902	12 mm	28.5	113.0	75
MIA M28-FLR	805903	28 mm	43.5	122.5	190
MIA M10S-FLR	805904	10 mm	28.7	119	75
MIA M12S-FLR	805905	12 mm	28.5	113	75

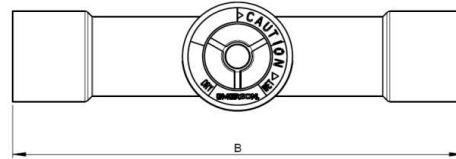

Note: When selecting also observe the information in the operating instructions. Available on EMERSON website www.climate.emerson.com/en-gb

Technical Data

Maximum working pressure PS	35 bar
Test pressure PT	49.5 bar
Medium compatibility	R290, mineral-. alkyl benzene and ester lubricants
Connections	ODF extended copper tubes. solder connections only

Pressure drop	negligible
Operating temperature TS	-40...+100°C
External leakage (100%-production tested with Helium- Spectrometer)	5.0x10-6 mbar l/sec = 4.9x10-6 cc/sec
Standards	EN 12178

Determining the Moisture Content with the Color Code

Refrigerant	Liquid temperature (°C)	Moisture content in mg Water per kg refrigerant (ppm)			
		blue Dry	purple	fuchsia Caution	rose Caution wet
R290	25	2	4	9	14
	38	5	8	18	29
	52	10	16	36	59



Note: In area "Caution" and "Caution wet" filter drier should be changed.

**Product Material Compatible with
R290 / R1270
only for non-explosive Environment**

EXD-HP1/2 Stand-alone Superheat/Economizer Controller

In compliance with EN/IEC 60335-2-40/89 EXM/L valves are qualified to use with R290. **EXD-HP1/2** are stand-alone universal superheat and or economizer controllers for heat pumps, heating units, air conditioning and close control units as well as refrigeration display cases.

Features

- Self-adapting superheat/economizer control in conjunction with EMERSON stepper motor driven electronic expansion valves EXM/EXL
- Discharge hot gas temperature control by wet refrigerant vapor/vapor injection to compressor
- EXD-HP1: Controller with one EXV output
- EXD-HP2: Controller with two independent EXV outputs
- Controllers as slave with Modbus (RTU) communication capability. All data (read/write) accessible by any third-party controller having modbus communication (RTU)
- Upload/download key (accessory) for transmission of parameter settings among controllers with the same setting
- Low pressure switch and freeze protection function
- Manual positioning of valve(s)
- Limitation of evaporating pressure (MOP)
- Low/high superheat alarm
- Monitoring of sensors and sensor wiring and detection of sensor and wiring failures
- Integrated display (3-digits LEDs) and key board
- Electrical connection via plug-in type screw terminals (included with controller)
- DIN rail mounting housing
- OEM product: Box order quantities: 20 pieces (Multi-pack)



EXD-HP2

Selection Table

Type	Description	Part No.	
		Multipack (20 pcs)	Single pack
Controllers			
EXD-HP1	with 1 EXV output	807836M	807836
EXD-HP2	with 2 EXV outputs	807837M	807837
Valves / Coils			
EXM-B0A	Electronic expansion valve	800399M	-
EXM-B0B		800400M	-
EXM-B0D		800401M	-
EXM-B0E		800402M	-
EXM-125	Coil 12 VDC	800403M	-
EXL-B1F	Electronic expansion valve	800405M	-
EXL-B1G		800406M	-
EXL-125	Coil 12 VDC	800407M	-
Temperature sensor			
ECP-P30	Temperature sensor with 3 m cable	-	804495
Pressure transmitters / plug and cable assembly			
PT5N-07P	Sensing pressure range -0.8...7 bar, brazing connection	805350M (25 pcs)	805350
PT5N-30P	Sensing pressure range 0...30 bar, brazing connection	805352M (25 pcs)	805352
PT4-M15	M12 Plug and cable, 1.5 m cable length	804803M	804803
PT4-M30	M12 Plug and cable, 3.0 m cable length	804804M	804804
PT4-M60	M12 Plug and cable, 6.0 m cable length	804805M	804805

Note1: For further detail please see pages of EXM/L and PT5N Technical Bulletin.



EXD-HP1/2 have potential ignition source and do not comply with ATEX requirements. Installation only in "non explosive location".

EXD-HP1/2 Stand-alone Superheat/Economizer Controller

Technical Data

EXD-HP1/2

Supply voltage	24 VAC/DC $\pm 10\%$
Power consumption	EXD-HP1: Max. 15VA EXD-HP2: Max. 20VA
Digital inputs	EXD-HP1: Two, each potential free EXD-HP2: Three, each potential free
Relay output	SPDT contacts. AgSnO Inductive (AC15) 24 V AC: 1 A Resistive: 24 VAC/DC: 4 A
Plug-in connector size	Removable screw version wire size 0.14...1.5 mm ²
Applied directive	LVD, EMC, RoHS
Compliance with	DIN EN60335-1 DIN EN 55014-1, DIN EN 55014-2
Selectable Refrigerants	R22, R134a, R410A, R32, R407C, R290

Protection class	IP20
Housing	Self-extinguishing ABS
Mounting	DIN rail mounted
Temperatures storage	-20...+65°C
operating	-10...+60°C
Relative humidity	0...85% RH, non-condensing
Weight	175 g
Marking	CE

Input Sensors. Output Valves

Description	Specification
Temperature input	ECP-P30 (3 m cable length) Range: -30...+150°C
Pressure sensor input	PT5N Signal: 4...20 mA
Electronic expansion valves (stepper motor) output	EXM and EXL series

Dimensions (mm)

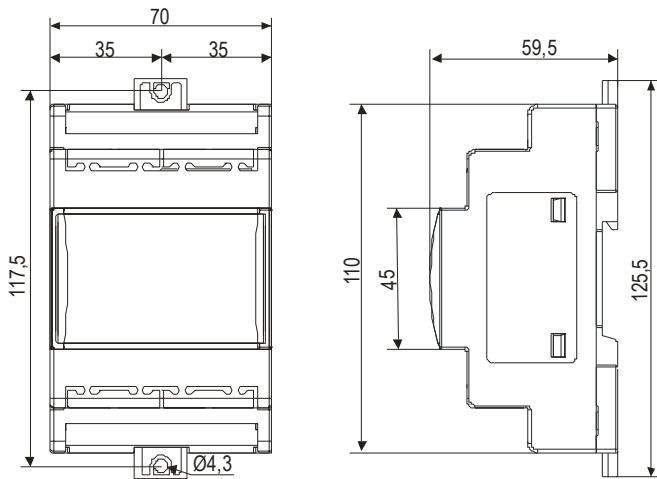

EXD-SH1/2 Controller for EX4-7-...-FLR with ModBus Communication Capability

EXD-SH1/2 are stand-alone universal superheat and or temperature controllers for air conditioning units or refrigeration systems.

Features

- EXD-SH1: Control of one valve
- EXD-SH2: Control of two valves in two independent circuits
- Main function

	Circuit 1	Circuit 2
EXD-SH1	Superheat or temperature control	
EXD-SH2	Superheat or temperature control	Superheat Control

- Other functions: Limitation of evaporating pressure (MOP), Low pressure switch, freeze protection and manual positioning of valve(s)
- Self-adapting superheat control function in conjunction with EMERSON EX4-7-...-FLR
- Modbus (RTU) communication
- Integrated keyboard with two lines display
- Monitoring of sensors and detection of sensor (ECN.../PT5N...P-FLR) /stepper motor wiring failures
- Optional upload/download key (accessory) for transmission of parameter settings among controllers with the same setting
- Low/high superheat alarm as well as other function alarms
- Electrical connection via plug-in type screw terminals included with controller and Micro Molex EXD-M03 (must be ordered separately)
- DIN rail mounting housing

Note: Software modification for selection refrigerants R290 / R1270 is pending. (Contact local sales offices for availability)





EXD-SH2



EXD-M03

Selection Table

Type	Description	Part No.	
		Multipack (25 pcs)	Single pack
Controllers			
EXD-SH1	Controller for single refrigeration circuit	-	807855
EXD-SH2	Controller for two independent refrigeration circuits	-	807856
EXD-M03	Molex terminal with 3 m wires	-	807865
Valves / plug and cable assembly 			
EX4-7...FLR	Details, please see page 7-10	page 7-10	page 7-10
EXV-M60 FLR	M12 Plug for EX4-7...-FLR, loose wires, 6m cable length	-	804666
Temperature sensor			
ECN-N30	Temperature sensor with 3 m cable	-	804496
ECN-N60	Temperature sensor with 6 m cable	-	804497
Pressure transmitters / plug and cable assembly 			
PT5N-07P-FLR	Sensing pressure range -0.8...7 bar, brazing connection	805390M	805390
PT5N-30P-FLR	Sensing pressure range 0...30 bar, brazing connection	805389M	805389
PT4-M60 FLR	M12 Plug and cable, 6.0 m cable length	-	804806
Uninterruptible Power supply			
ECP-024	Backup battery with two outputs for two controllers	-	804558
K09-P00	Electrical Terminal Kit for ECP-024	-	804560
EXD-PM	Super cap for only EXD-SH1 (two pieces of EXD-PM required for one EXD-SH2)	-	807854



EXD-SH1/2, ECP-024 & EXD-PM have potential ignition source and do not comply with ATEX requirements. Installation only in "non explosive location".

Description of Functions

Controllers are featured with a main function as superheat controller or temperature controller. The main function is selectable.

Superheat Control of Evaporators or Economizers

This function requires the connection of temperature sensor(s) as well as pressure transmitters(s). The other functions are:

- MOP control: enables the limitation of saturated temperature of suction line (outlet of evaporator/economizer)
- Low pressure behaves similar to low pressure switch including alarm conditions
- Freeze protection is based on saturated temperature from converting measuring suction pressure. It provides alarm condition below certain adjusted temperature.

Temperature Controller

The function is to maintain desired temperature by modulating refrigerant mass flow. If controller is operated as temperature controller, the connection of pressure transmitter is not required.

In order to fulfill varieties of the applications, the refrigerant mass flow variation can be set according temperature increase or decrease.

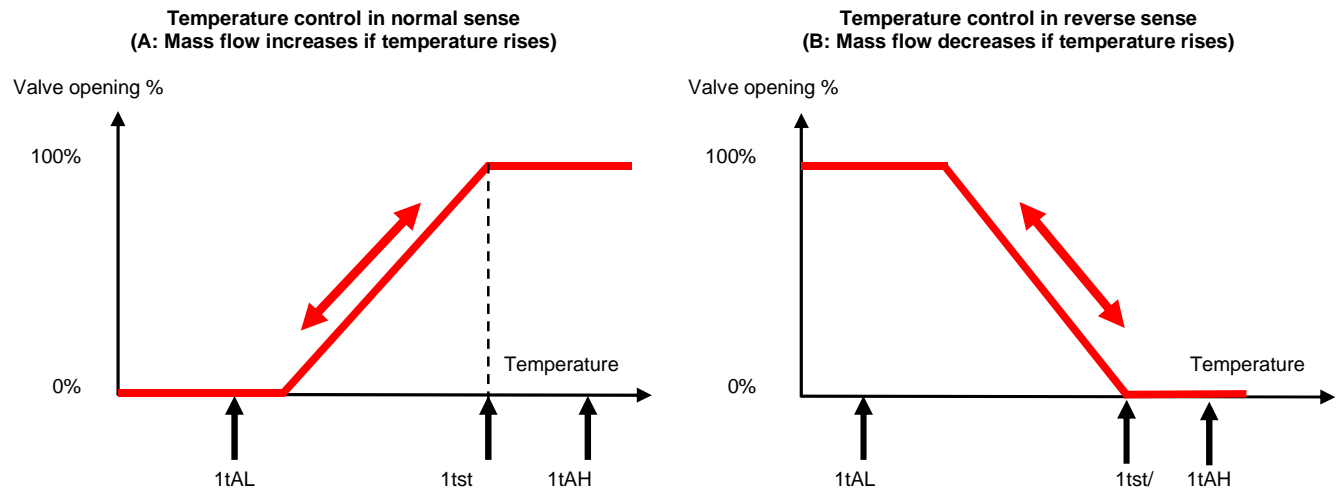

Examples of Applications:

- Temperature control by throttling suction mass flow (normal sense. A)
- Temperature control by modulating hot gas into inlet or outlet of evaporators (reverse sense. B)
- Discharge temperature control by injecting liquid (normal sense. A)

Head pressure control by means of temperature control (normal sense. A)

EXD-SH1/2 Controller for EX4-7-...-FLR with ModBus Communication Capability

Wiring

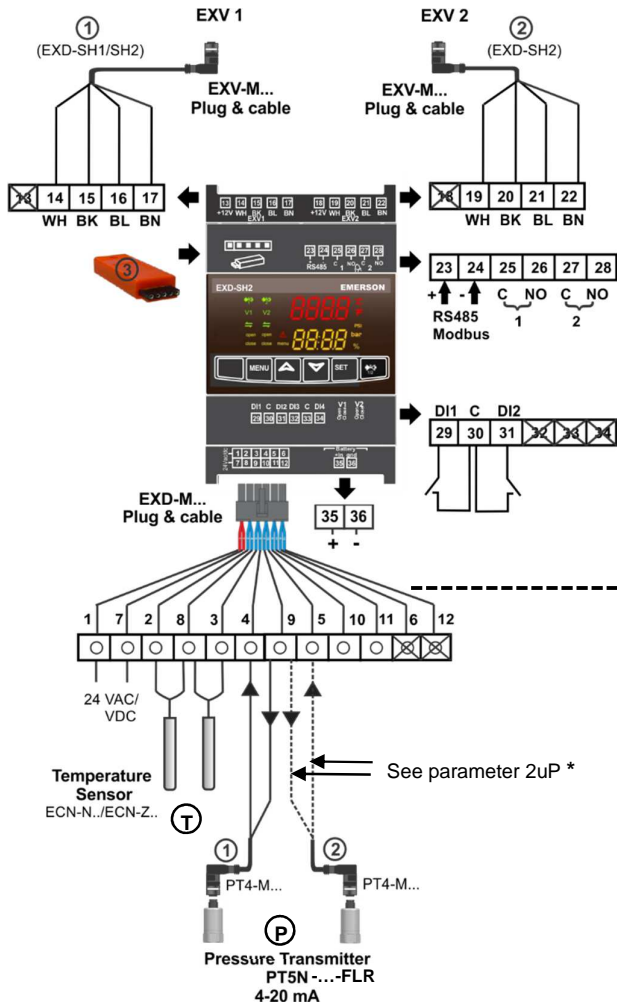

Wiring options: UPS (ECP-024) /Supercap (EXD-PM)

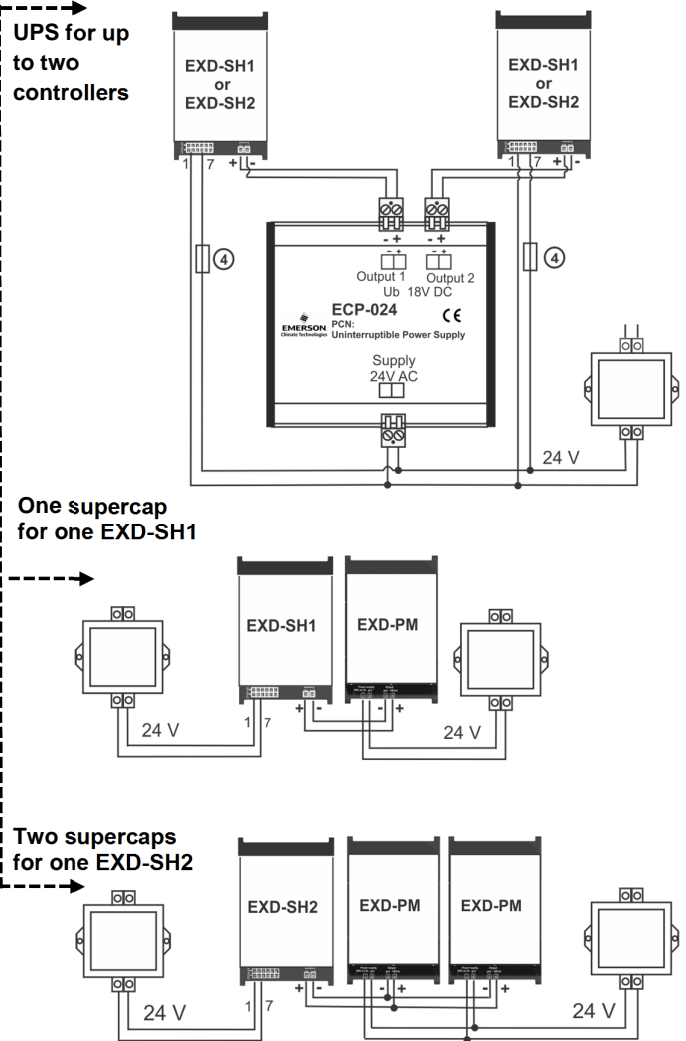

①	Circuit 1 (EXD-SH1/SH2)		Electronic expansion valve circuit 1 (EXV1) EXV-M...-FLR Electrical plug: wire colors WH-white BK-black BL-blue BN-brown
②	Circuit 2 (EXD-SH2)	14-17	Electronic expansion valve circuit 2 (EXV2) EXV-M...-FLR Electrical plug: wire colors WH-white BK-black BL-blue BN-brown
③	Download/upload key		
1 & 7	Supply voltage 24 VAC/DC	19-22	Electronic expansion valve circuit 2 (EXV2) EXV-M...-FLR Electrical plug: wire colors WH-white BK-black BL-blue BN-brown
2 & 8	Temperature sensor circuit 1	23 & 24	RS485 (+/-terminal)
3 & 8	Temperature sensor circuit 2	25 & 26	Alarm relay circuit 1 (C. NO) – Suitable for 24 VAC/DC
4 & 5	PT5N-...-P-FLR circuit 1 & circuit 2 (white wire: 4...20 mA signal)	27 & 28	Alarm relay circuit 2 (C. NO) – Suitable for 24 VAC/DC
9	+ 12 VDC Voltage input for PT5N-...-P-FLR (brown wire)	29 & 30	Digital input circuit1 (DI1) – Dry contact, potential free
Alternative ratiometric third Party Pressure Transmitter (ATEX certified):		31 & 30	Digital input circuit 2 (DI2) – Dry contact, potential free
4 & 5	Pressure transmitter circuit 1 & circuit 2 (0.5...4.5 V signal)	35 & 36	Battery/Super capacitor connection terminal
11	+ 5 VDC voltage input	④	Fuse EXD-SH1 (1A). EXD-SH2 (2A)
10	GND Ground	6.12.13. 18.32-34	Not used (Terminals on EXD-SH12)

Note: No hard failure detection if ground wire of transmitter to be interrupted.

*) Parameter 2uP with No. 8 = only Pressure sensor circuit 1 is used

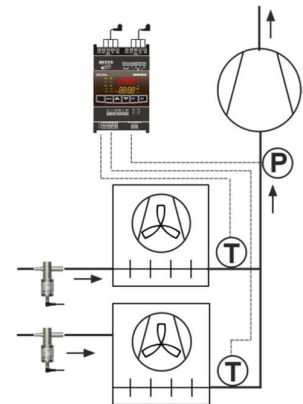

EXD-SH1/2 Controller for EX4-7-...-FLR with ModBus Communication Capability

Technical Data: EXD-SH1/2

Supply voltage	24 VAC/DC \pm 10%. 50/60 Hz	Mounting	DIN rail mounted
Power consumption	EXD-SH1: Max. 25 VA EXD-SH2: Max. 50 VA	Temperatures operating/ surrounding	storage -25...+60°C 0...+55°C
Terminals 1 to 12	Suitable for 12 poles molex plug	Relative humidity	20...85% non-condensing
Terminals 13 to 36	Suitable for removable screw version: wire size 0.14...1.5 mm ² Included in controller delivery	Accessory (12 poles molex plug with 3 m cable)	Type: EXD-M03 (to be ordered separately)
Protection class	IP 00	Housing	Self-extinguishing ABS
Compliance	EMC, RoHS	Weight	320 g
Marking			

Input, Output EXD-SH1/2

Description	Specification
Analogue input(s): NTC Temperature sensor	ECN-N... (-45°C...+50°C sensing range)
Analogue input(s): 4...20 mA pressure transmitters Analogue input(s): 0.5...4.5 V pressure transmitters	PT5N-...-P-FLR Third party ratio metric pressure transmitters (ATEX certified) (total error: \leq 1%)
Digital input(s)	Dry contact. potential free
Digital output(s): Alarm relay(s) Contact is closed: During alarm condition Contact is open: During normal operation and supply power OFF	Resistive Load 24 VAC/DC. max. 1 A Inductive Load 24 V AC. max. 0.5 A
Communication	RS485 RTU Modbus. two wires
Stepper motor output	Valves: EX4-7-...-FLR

Technical Data Optional EXD-PM Supercap

Supply voltage	24 VAC/DC \pm 10%. 50/60 Hz	Protection class	IP 20
Output voltage	12 VDC	Mounting	DIN rail mounted
Max. output current	1.2 A 350 mA during charging	Temperatures operating/ surrounding	Storage -20...+70°C -10...+60°C
Power consumption	12 VA	Housing	Self-extinguishing ABS
Terminals	Suitable for removable screw version: wire size 0.14...1.5 mm ²	Relative humidity	20...85% non-condensing
Output: to driver/controller	Suitable for one EXD-SH1 Two EXD-PM for one EXD-SH2	Marking	
Charging time	60 seconds	Weight	125 g
Max. cable length between EXD-PM and EXD-SH1/2	50 cm AWG18 wire size		

EXD-SH1/2 Controller for EX4-7-...-FLR with ModBus Communication Capability

Technical Data Optional Uninterruptible Power Supply ECP-024

Backup battery type	Lead acid gel rechargeable battery	Mounting	DIN rail mounted
Number of backup batteries	2. each 12 VDC. 0.8 Ah	Temperatures	Storage -20...+65°C operating/ surrounding -10...+60°C
Supply voltage	24 VAC ±10%. 50-60 Hz	Housing	Aluminum
Output voltage. UB	18 VDC	Relative humidity	< 90% non-condensing
Number of outputs to drivers	2	Connection	Screw terminals for wire size 0.5...2.5 mm ²
Battery recharge time	approximately 2 hours	Accessories: Terminals	K09-U00
Protection class	IP 20	Weight	1200 g
Marking	CE		

Dimensions (mm)

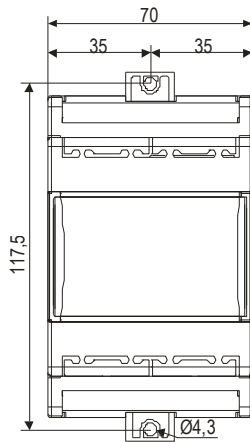

EXD-SH1/2 or EXD-PM

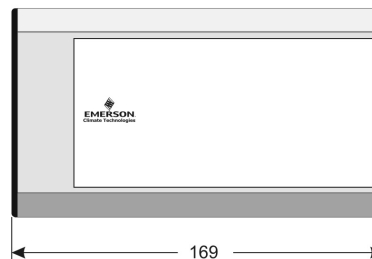
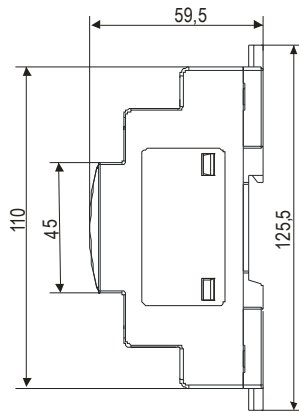

ECP-024

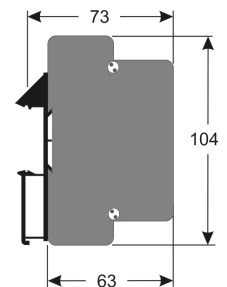

EC3-P32 / -P33 Superheat Controller & Standard ECD-002

EC3-P32 / -P33 are stand-alone universal superheat controllers. **EC3-P32** offers remote access with built-in TCP/IP Ethernet communications and WebServer functionality. Any standard WebBrowser (e.g. Internet Explorer® or Mozilla Firefox) can be used for monitoring or parameter setting. **EC3-P33** has no network communication.

Features EC3-P33 / EC3-P32

- Superheat control in conjunction with EMERSON stepper motor driven Electrical Control Valves EX4-7-...FLR
- Low superheat alarm and MOP function
- Feed through of 4...20mA signal from evaporator pressure sensor to analogue output. This may also be connected to pressure input of any other controller to avoid need for multiple pressure sensors
- Monitoring of sensors and sensor wiring and detection of sensor and wiring failures
- Intelligent alarm management in order to protect the compressor i.e. fail-safe operation
- Integral rechargeable battery to close electrical control valve in case of power loss
- Electrical connection via plug-in type screw terminals
- Aluminum housing for DIN rail mounting



EC3-P32



Additional Features EC3-P32 only

- High superheat alarm
- Low pressure switch function/alarm
- Freeze protection function/alarm
- Pump down function



EC3-P33 with ECD-002

Selection Table

Type	Description	Part No.	
		Multipack (25 pcs)	Single pack
Controllers			
EC3-P33	Universal superheat controller with network communication	-	807858
K03-X33	Terminal kit EC3-P33	-	807645
EC3-P32	Universal superheat controller <u>without</u> network communication	-	807857
K03-X32	Terminal kit EC3-P32	-	807644
ECD-002	Optional Display/keypad unit	-	807657
Temperature sensor			
ECC-N10	Connection cable EC3 to ECD-002	1 m cable length	807860
ECC-N30		3 m cable length	807861
ECC-N50		5 m cable length	807862
Valves / plug and cable assembly			
EX4-7...FLR	Details, please see page 7-10 	page 7-10	page 7-10
EXV-M60 FLR	M12 Plug for EX4-7...-FLR, loose wires, 6m cable length	-	804666
Temperature sensor			
ECN-N30	Temperature sensor with 3 m cable	-	804496
ECN-N60	Temperature sensor with 6 m cable	-	804497
Pressure transmitters / plug and cable assembly 			
PT5N-07P-FLR	Sensing pressure range -0.8...7 bar, brazing connection	805390M	805390
PT5N-30P-FLR	Sensing pressure range 0...30 bar, brazing connection	805389M	805389
PT4-M60 FLR	M12 Plug and cable, 6.0 m cable length,	-	804806
Transformer			
ECT-323	230VAC Input, 24V output, Din rail mounting	25 VA, for one set of controller and valve	804424
ECT-623		60 VA, for set of two controllers and valves	804421
Replacement battery kit for EC3		-	807790



EC3-P32/P33, ECD-002 & ECT-323/623 have potential ignition source and do not comply with ATEX requirements. Installation only in "non explosive location".

Wiring Diagram

EC3-P33

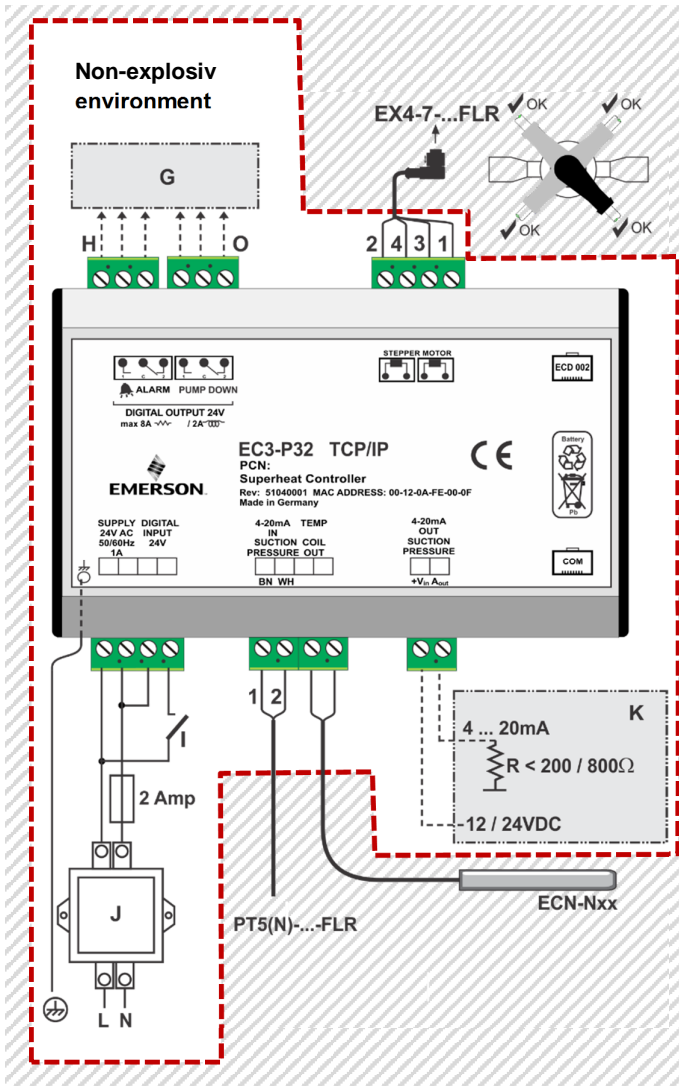

EC3-P32

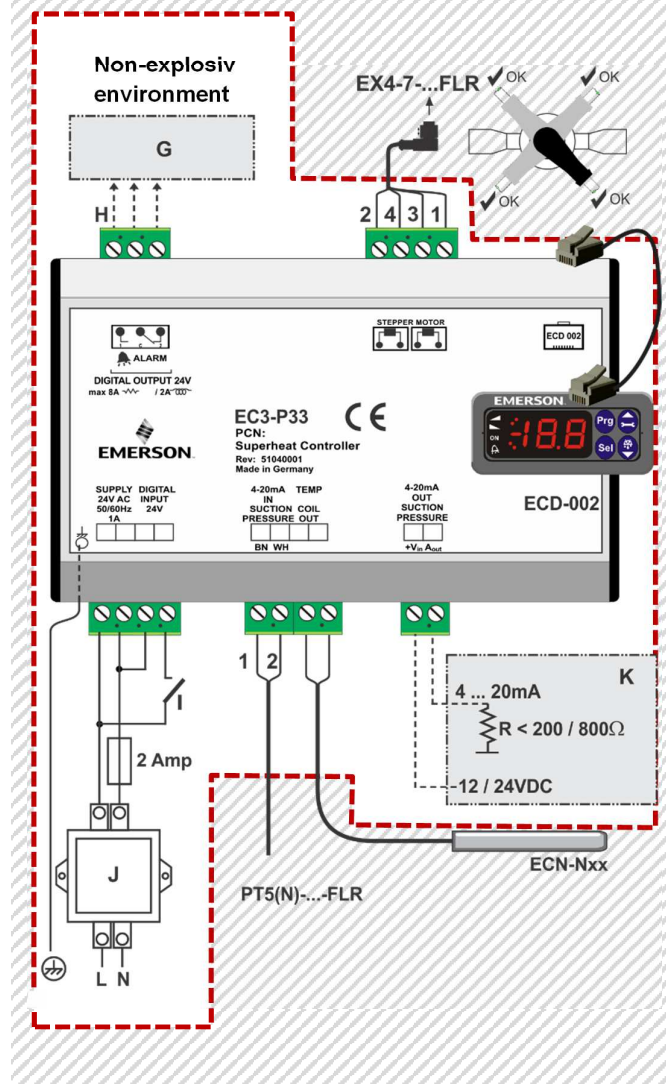

- 2: White 4: Black 3: Blue 1: Brown wire
- G: Remote control panel, system controller
- H: Alarm relay, dry contact; Relay coil is not energized at alarm condition or power off.
- ⚠ **The use of the relay is essential to protect the system in case of power failure if the communications interface or the ECD-002 is not utilized**
- I: Digital input (0V/open = Stop; 24V/closed = Start)
- J: Transformer Class II, 24VAC secondary / 25VA
- K: Third party controller (can use analog output signal of EC3)
- O: Pump down relay, dry contact; Relay is energized during normal operation.
- Note: The internal resistor of a third-party controller must fulfill the following conditions:
 Supply voltage: 12VDC: $R \leq 200\Omega$
 Supply voltage: 24VDC: $R \leq 800\Omega$

Network Connection EC3-P32 only:

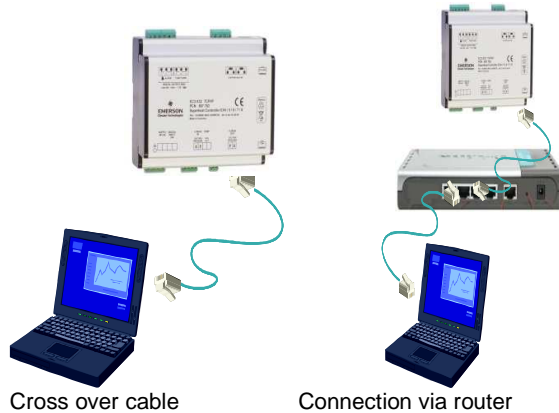

EC3-P32 / -P33 Superheat Controller & Standard ECD-002

Technical Data

EC3-P32 / -P33

Supply voltage	24 VAC ±10%. 50/60Hz
Digital input	24 VAC ±10%. 50-60Hz 24 VDC ±10%
Power consumption	25 VA max. including connected ECV and display/keyboard
Internal battery charging time	Approximately 2 hours if battery is fully empty
Plug-in connector size	Removable screw version wire size 0.14...1.5 mm ²
Ground connection	6.3 mm spade earth connector
Marking	CE
Protection class	IP 20 (DIN EN60529)
Vibration	4 g. 10-1000 Hz
Temperature storage operating	-20...+65°C 0...+60°C +1...+25°C for optimum battery life
Applied directives EMC LVD RoHS	EN 61326, EN 50081, EN 61000-6-2, EN 61000-4-2, EN 61000-4-3, EN 61000-4-4, EN 61000-4-5, EN 61000-4-6, EN 61000-4-11
Humidity	0...80% r.h. non-condensing
Weight	~ 800 g
Mounting	DIN rail mounted

ECD-002 Display Unit

Supply	From EC3 Series Controller via connecting cable
LED indicators	Valve opening, valve closing, alarm, demand
Display LED	Numeric segmental display. 2½-digits, Red, with automatic decimal point between ±19.9, switchable between °C and °F
Connecting cable	ECC-Nxx or standard CAT5 patch cord with RJ45 connectors
Temperature storage operating	-20...+65°C 0...+60°C
Humidity	0...80% r.h. non-condensing
Protection class (DIN EN 60529)	IP65 (mounting in front panel with gasket)
Weight	~ 52 g
Mounting	Panel mount (71 x 29 mm cutout)



ECD-002

Dimensions (mm)

EC3-P32 / - P33

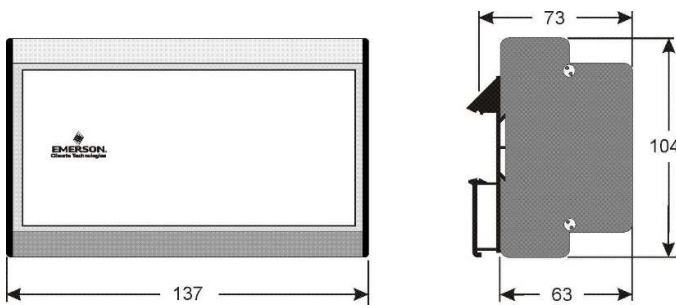

ECD-002

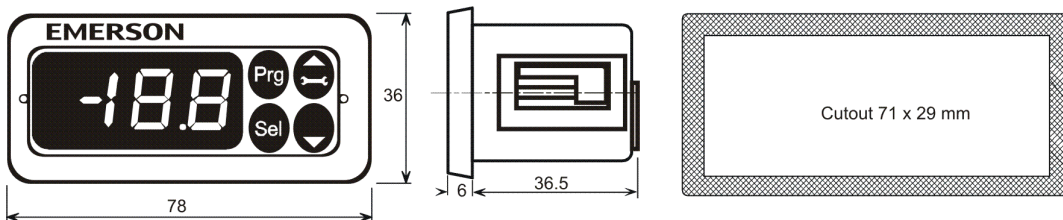

CSS-25U / CSS-32U / CSS-32W Compressor Soft Starter

The first **VDE certified Compressor Soft Starter** for safety of household. It is used for switching, protection and starting current limitation of single phase compressors in residential heat pumps, refrigeration and air-conditioning applications.

Features

- For motors with maximum operating current up to 25 A / 32 A
- Limitation of starting current to less than 45 A resp. 30 A, see Selection table
- Self-adjusting for use in 50 Hz or 60 Hz supply
- Self-adjusting to motor current - no manual adjustment or calibration necessary
- Alarm relay output
- Start capacitor for improved motor acceleration is switched off after start
- Low voltage shutdown
- Locked rotor recognition and shutdown
- Delay function to limit number of motor starts per hour
- Thyristor protected contactor for long life
- No extra motor contactor needed
- Self-diagnostics
- Mounting clip for easy installation allows DIN rail mounting in two directions
- Easy wiring by cage type screw terminals
- CSS-...U: 4 mm² cross section terminals
- CSS-...W: 6 mm² cross section terminals



CSS-32U Soft Starter



CSS-32W Soft Starter

Selection Table

Type	Part No.	Description	Ø Screw Terminals	Nom. Compr. Current	Max. Start Current
CSS-32U	805204	Compressor Soft Starter incl. mounting clip	4 mm ²	32 A max	45 A
CSS-32U	805204M	Box with 20 pieces, mounting clips	4 mm ²	32 A max	45 A
CSS-32W	805211	Compressor Soft Starter incl. mounting clip	6 mm ²	32 A max	45 A
CSS-32W	805211M	Box with 20 pieces, mounting clips	6 mm ²	32 A max	45 A
CSS-25U	805205	Compressor Soft Starter incl. mounting clip	4 mm ²	25 A max	45 A
CSS-25U	805205M	Box with 20 pieces, mounting clips	4 mm ²	25 A max	45 A
CSS-25U	805209	Compressor Soft Starter I _{max} 30 A incl. mounting clip	4 mm ²	25 A max	30 A
CSS-25U	805209M	Box with 20 pieces, mounting clips	4 mm ²	25 A max	30 A

Note1: *) M= Multipack = 20 pieces,



These devices have potential ignition source and do not comply with ATEX requirements. Installation only in "non explosive location".

Accessory

Type	Part No.	Description
K00-003	807663	3-pol screw connector to alarm output for wires up to 2.5 mm ² ; bag with 50 pieces

CSS-25U / CSS-32U / CSS-32W Compressor Soft Starter

Technical Data

Operating voltage	230V 50/60 Hz nominal
Nominal compressor current	CSS-32U / - 32W: 32A max. CSS-25U: 25A max.
Maximum start current	CSS-32U / - 32W: 45A CSS-25U (805 205): 45A CSS-25U (805 209): 30A
Operating temperature	-20...+55°C non-condensing
Storage temperature	-20...+65°C non-condensing
Start capacitor	200...240 µF
Time delay after stop	0.5...5 Min

Alarm relay. AgNi (SPDT)	
Resistive (AC1) max.	250V~ / 3A 30V= / 3A
Flexible cable cross section CSS-32U/-25U all terminals CSS-32W (R. RC. L terminals)	0.25...4 mm ² 0.25...6 mm ²
Flexible cable cross section alarm output connector K00-003	0.25...2.5 mm ²
Max. vibration (at 10 to 1000 Hz)	4 g
Weight	430 g
Protection acc. IEC 529	IP20

Standards

EN 60947-1	Low voltage switchgear and control gear
EN 60947-4-2	Contactors and motor-starters - AC semiconductor motor controllers and starters
EMC 2014/30/EU	Electromagnetic Compatibility (EMC) Directive
LVD 2014/35/EU	Low Voltage Directive

EN 60335-1	Safety of household and similar electrical appliances -
EN 60335-2-40	Part 2-40 Particular requirements for electrical heat pumps, air-conditioners and dehumidifiers
ROHS 2002/95/EC	Restriction of Hazardous Substances Directive
Marking	 VDE Reg.-Nr. D967 / D663

Dimensions (mm)

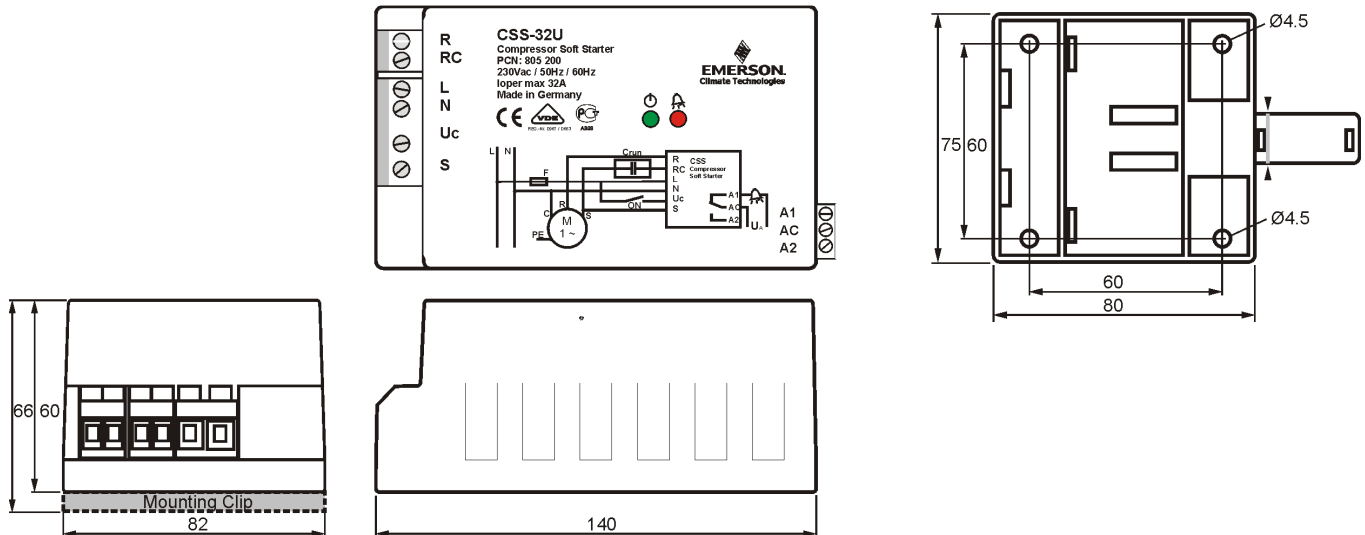

Oil Management OM3-020P TraxOil

The **OM3-020P TraxOil** oil management is a self-contained system which provides both functions of oil level monitoring and active oil level balancing including alarm relay activation for compressor protection.

Features

- Supply 24 VAC or 230 VAC
- 3 Zone Level Control by using precise Hall-Sensor measurement, not prone to errors by foaming or light like optical sensors
- SPDT output contact for compressor shut down or alarming, rating 230 VAC / 3 A
- Easy installation by sight-glass replacement and front side mounting without nuts
- Self-contained unit with oil level sensor and integral solenoid to manage oil level supply
- Alarm, status and level indication by LED's
- Adapter with brazing connection for Copeland Compressors





OM3-020P TraxOil



- **Only for use with R290!**
- **OM3-020P and ESC-24VAC have potential ignition source and do not comply with ATEX requirements. Installation only in "non explosive location".**
- **OM3-020P has special O-rings released for propane. Installation in combination with OM0-CCP brazing adapter only.**

Selection Table

Type	Description	Part No.	
Base Unit			
OM-020P	Max. working pressure 46 bar, Time delay 20 sec	805270	
Adapter			
OM0-CCP	22.5 mm braze adapter, see dimensions	805260	
Cables Alarm Relay			
OM3-N30	Connection to Relay	3 m cable length	
OM3-N60		6 m cable length	
OM3-N100		10 m cable length	
Solenoid coil			
ESC-24VAC	Supply voltage 24 VAC $\pm 10\%$, 50 Hz, 17VA, incl. screw cap with 2x O-ring & fixing retainer		801033
ESC-K01	Screw cap (incl. 2x O-ring & fixing retainer)		801034
Cable Assembly Power Supply and Solenoid			
OM3-P30	24 V, 3 m	805151	
OM3-P60	24 V, 6 m	805152	
OM3-P100	24 V, 10 m	805153	

Note: When selecting also observe the information in the operating instructions. Available on EMERSON website www.climate.emerson.com/en-gb.

Oil Management OM3-020P TraxOil

Technical Data

Markings	CE under: Low Voltage Directive 2014/35/EU. EMC Directive 2014/30/EU
Applied Standards	EN 12284, EN 378, EN 61010, EN 50081-1, EN 50082-1
Max. working pressure PS Max. test pressure PT Burst Pressure	35 bar 39 bar 175 bar
Supply voltage / total power with 24VAC ESC coil	24VAC±10%, 50 Hz, 17VA
Solenoid valve MOPD	21 bar
Vibration resistance (EN60068-2-6)	max. 4g, 10...250 Hz
Medium temperature Ambient/Storage temperature	-20...+80°C -20...+50°C
Medium compatibility	R290

Materials: Body and Adapter Screws Sight Glass	Aluminum (EN AW 6060) stainless Steel (ISO 4762) nickel-plated Steel (ISO 2081)
Flow rate at $\Delta P = 3.5$ bar	0.9 ltr/min. water at 20°C ambient
Orientation of base unit Level control	Horizontal. +/- 1° 40%...60% of sight glass height
Alarm contact	max. 1A, 24VAC SPDT dry contact
Time Delay Alarm	20 sec.
Time Delay Filling	10 sec.
Protection class	IP65 (IEC529/EN 60529)
Weight: 24V System 230V System	750...920 g incl. adapter 1100...1270 g incl. adapter
Oil connection	7/16"-20 UNF male, with strainer and O-ring (replaceable)

Dimensions (mm)

Base Unit with adapter and coil ESC:

