

Electronic Unit Controller

TABLE OF CONTENTS

Safety	3	5. Parameter List	11
Safety Instructions	3	6. Controller Wiring	13
Safety Icon Explanation	3	6.1. Non-Fan Cycling Wiring Schematic	13
Instructions Pertaining to Risk of Electrical Shock, Fire, or Injury to Persons	4	6.2. Fan Cycling Wiring Schematic	13
Safety Statements	4	6.3. Copeland PerformanceAlert Connection	14
1. Introduction	5	6.4. Additional Controller Inputs	14
1.1. Technical Specifications	5	7. Alarms and Notifications	14
1.2. Pressure Probe Error Bypass	6	7.1. Discharge Line Temperature Protection	15
1.3. Bump Start	6	7.2. UL High Pressure Safety Control	15
1.4. Compressor Shutdown (Optional Feature)	6	8. Electronic Unit Controller Replacement	16
2. Installation and Controller Operation Instructions	6	8.1. Silver Electrical Box Applications	16
2.1. Condensing Unit Installation Instructions	6	8.2. Small Black Electrical Box Applications	16
2.2. Controller Display	6	8.3. Plastic Retainer Applications (Large Black Electrical Box and X-Line Units)	17
2.3. Button Descriptions and Key Combinations	7	8.4. Setting Controller Parameters After Replacement	17
2.4. Viewing Temperature Readings	8	8.5. Replacing -00 Controller with -01 or -02 Controller	18
2.4.1. Viewing Setpoints	8	9. Thermistor Temperature/Resistance Values for Condenser Temperature Sensor	19
2.5. Changing a Parameter Value	8	9.1. Thermistor Temperature/Resistance Values for Discharge Temperature Sensor	20
2.6. Entering the Advanced Options Menu	8	10. Measuring Pressure/Voltage Values for Suction Pressure Transducer	20
2.6.1. Moving Parameters between Programming Menu and Advanced Options Menu 8	8	11. Troubleshooting Guide	22
2.6.2. Programming Using a Hotkey	9	12. Parts Kits	25
2.7. Locking the Keypad	9	13. For Service Only	28
2.8. Unlocking the Keypad	9		
2.9. Resetting Alarm and Runtime Counters	10		
3. Alarm Menu	10		
4. Service Menu 	10		



TABLE OF FIGURES

Figure 1 Attached Label.....	5	Figure 12 Example of Default Parameters and Schematic on Inside Label	18
Figure 2 Factory default settings.....	5	Figure 13 Jumper Cable with Blue Wire.....	18
Figure 3 Controller Display	6	Figure 14 Measuring Suction Pressure Transducer Voltage	21
Figure 4 Programming Using a Hotkey.....	9	Figure 15 – Part # 039-0026-06 New pressure transducer and connection cable	28
Figure 5 Non-Fan Cycling Wiring Schematic.....	13	Figure 16 – Part # 039-0026-02 Legacy pressure transducer and cables.	28
Figure 6 Fan Cycling Wiring Schematic.....	13		
Figure 7 Wiring Schematic Example for Controller with Copeland PerformanceAlert.....	14		
Figure 8 Wiring Schematic Example for Optional Thermostat.....	14		
Figure 9 Silver Electrical Box	16		
Figure 10 Small Black Electrical Box	16		
Figure 11 Large Black Electrical Box	17		

TABLES

Table 1 LED Descriptions	7
Table 2 Button Descriptions.....	7
Table 3 Key Combinations.....	7
Table 4 Parameters	11
Table 5 Factory Set Parameters	12
Table 6 Alarms and Notifications	14
Table 7 Copeland PerformanceAlert Error Codes	15

Revision Tracking R6

- Pg. 1 – 1st. Page Picture changed.
- Pg. 6 – Section 1.4 Compressor Shutdown added.
- Pg. 11 – LMO and LPA parameter added to Table 4.
- Pg. 21-22 – Causes added on Troubleshooting Guide
- Pg. 21 – Figure 14 (Measuring Suction Pressure Transducer Voltage) modified.
- Pg. 26 – Equivalence chart with Dixell products included.
- Pg. 27 – Service Section explaining changes on transducer and cables.

Safety Instructions

Copeland™ brand products are manufactured according to the latest U.S. and European Safety Standards. Particular emphasis has been placed on the user's safety. Safety icons are explained below and safety instructions applicable to the products in this bulletin are grouped on Page 3. These instructions should be retained throughout the lifetime of the compressor. You are strongly advised to follow these safety instructions.

Safety Icon Explanation



DANGER indicates a hazardous situation which, if not avoided, will result in death or serious injury.



WARNING indicates a hazardous situation which, if not avoided, could result in death or serious injury.



CAUTION, used with the safety alert symbol, indicates a hazardous situation which, if not avoided, could result in minor or moderate injury.







NOTICE is used to address practices not related to personal injury.



CAUTION, without the safety alert symbol, is used to address practices not related to personal injury.

Instructions Pertaining to Risk of Electrical Shock, Fire, or Injury to Persons

	<p>ELECTRICAL SHOCK HAZARD</p> <ul style="list-style-type: none"> • Disconnect and lock out power before servicing. • Discharge all capacitors before servicing. • Use compressor with grounded system only. • Molded electrical plug must be used when required. • Refer to original equipment wiring diagrams. • Electrical connections must be made by qualified electrical personnel. • Failure to follow these warnings could result in serious personal injury.
	<p>PRESSURIZED SYSTEM HAZARD</p> <ul style="list-style-type: none"> • System contains refrigerant and oil under pressure. • Remove refrigerant from both the high and low compressor side before removing compressor. • Never install a system and leave it unattended when it has no charge, a holding charge, or with the service valves closed without electrically locking out the system. • Use only approved refrigerants and refrigeration oils. • Personal safety equipment must be used. • Failure to follow these warnings could result in serious personal injury.
	<p>BURN HAZARD</p> <ul style="list-style-type: none"> • Do not touch the compressor until it has cooled down. • Ensure that materials and wiring do not touch high temperature areas of the compressor. • Use caution when brazing system components. • Personal safety equipment must be used. • Failure to follow these warnings could result in serious personal injury or property damage.
	<p>COMPRESSOR HANDLING</p> <ul style="list-style-type: none"> • Use the appropriate lifting devices to move compressors. • Personal safety equipment must be used. <p>Failure to follow these warnings could result in personal injury or property damage.</p>

Safety Statements

- Refrigerant compressors must be employed only for their intended use.
- Only qualified and authorized HVAC or refrigeration personnel are permitted to install commission and maintain this equipment.
- Electrical connections must be made by qualified electrical personnel.
- All valid standards and codes for installing, servicing, and maintaining electrical and refrigeration equipment must be observed.

1. Introduction

Using the Electronic Unit Controller with Copeland™ brand condensing units will provide many benefits to the contractor and end-user. It has been designed specifically for demanding refrigeration applications to ensure precision in installation and operation. While the Electronic Unit Controller will replace existing adjustable low-pressure controls, fan cycle switches, and other relays, it also has additional features. These features include bump start (where applicable), data storage, and short cycling protection. This controller does NOT replace the fixed high-pressure control required by UL.

The Electronic Unit Controller can be used on any condensing unit application with the appropriate sensors and relays that are factory installed on the condensing unit. This document will explain how Electronic Unit Controllers affect the installation process and how they can assist in troubleshooting

Factory-installed controllers are pre-programmed with the proper settings, resulting in little to no setup time. The unit comes with an attached label showing how to adjust the low pressure cut-in and cut-out (See **Figure 1**).

There is a label on the inside of the enclosure which lists all of the factory default settings for the controller (including those not adjustable), a basic controller wiring schematic, basic button descriptions, the controller part number, the pre-loaded program part number, and contact information (See **Figure 2**). This information can be used if a service replacement controller is needed.

1.1. Technical Specifications

Mounting: Panel mounting in a 71x29mm panel cut-out

Controller IP Rating: IP20

Front Panel IP rating: IP65

Power supply: 208/230Vac ±10%, 50/60Hz
120Vac ±10%, 50/60Hz

Power absorption: 3VA max

Relay outputs:

Compressor Relay: 250VAC, 16A FLA, 96A LRA

Fan Relay 1: 250VAC, 4.9 FLA, 29.4 LRA

Fan Relay 2: 250VAC, 1.9 FLA, 11.4 LRA

SPECIAL NOTE: EUC FAN CYCLING RELAYS ARE NOT APPROVED FOR USE WITH ECM MOTORS.

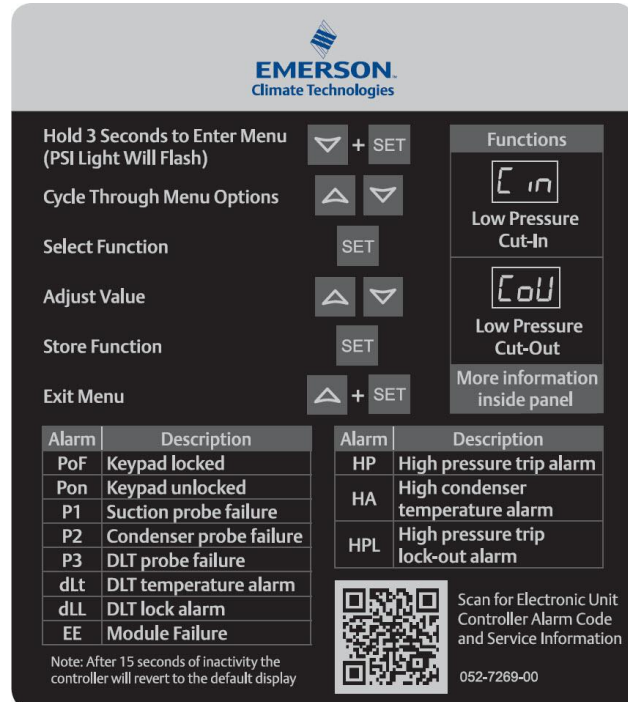

Figure 1 Attached Label

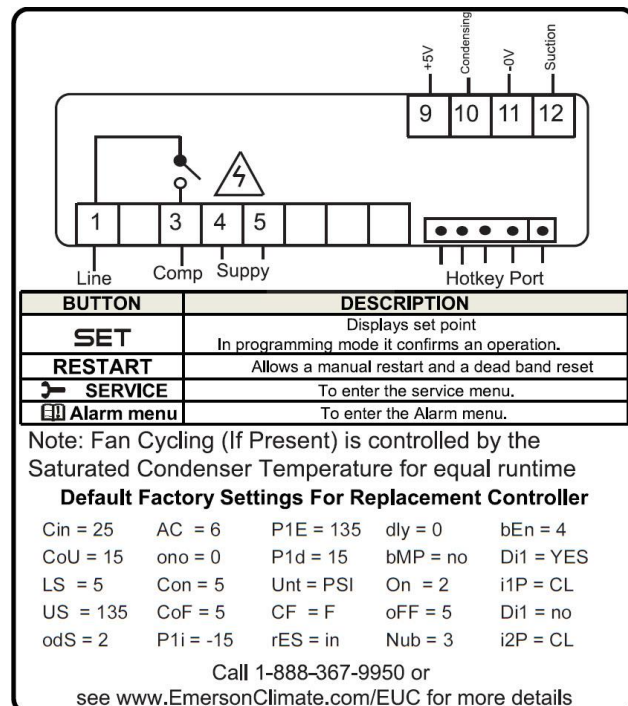

Figure 2 Factory default settings

Data storage: Non-volatile memory (EEPROM).
Rated impulsive voltage: 2500V; Overvoltage Category: II
Factory Installed Operating Range: -40 - 120°F Ambient
Non-Factory Installed Operating Range: -4 to 120°F Ambient

1.2. Pressure Probe Error Bypass

In the event where suction pressure rises above the controller's maximum value of 135 PSIG (this frequently happens during cleaning cycles or other off-cycle conditions), the controller will enter a pressure probe bypass mode during startup to allow the system to stabilize pressures. The controller will flash "135" on the display and the compressor will run continuously unless stopped by a high-pressure or temperature control. If suction pressure remains above 135 PSIG for more than 15 minutes, the controller will flash "P I" on the display and cycle the compressor on and off according to the time set with the "LON" and "LOF" parameters. These are set to 5 minutes by default and can be adjusted in the Advanced Options Menu (See [Section 2.6](#)).

1.3. Bump Start

Bump start is an optional feature which provides additional flooded start protection. Bump start drives refrigerant out of the oil, preventing the refrigerant from circulating through the compressor as a liquid and washing the oil film off of the load-bearing surfaces.

When bump start is enabled, the compressor is turned on for 2 seconds, then turned off for 5 seconds. This

occurs 3 times before the compressor runs normally. This allows refrigerant to exit the compressor without the oil being removed.

Bump start can be turned on in the Advanced Options Menu by changing "bnP" to "Y" (See [Section 2.6](#)).

1.4. Compressor Shutdown (Optional Feature)

In the event the suction pressure falls below the LAP (Pressure to end time), the compressor will shut down. This parameter is in the advanced options menu and is only enabled when the LMO (Minimum on Time) parameter is not set to zero.

2. Installation and Controller Operation Instructions

2.1. Condensing Unit Installation Instructions

Customer connections will not change, and in most cases, wiring to the unit will not change either. See [Section 6](#) for more information.

If the unit trips on low pressure during charging, the low pressure cut-out can be lowered to allow it to run. Be sure to adjust it back to the proper application setting after charging. See the appropriate Application Engineering Bulletin according to compressor model family.

2.2. Controller Display

The controller display is shown in **Figure 3**, below. **Table 1** provides a description of each of the labeled lights. The controller is defaulted to display the current suction pressure to three significant digits in pounds per square inch gage (PSIG).

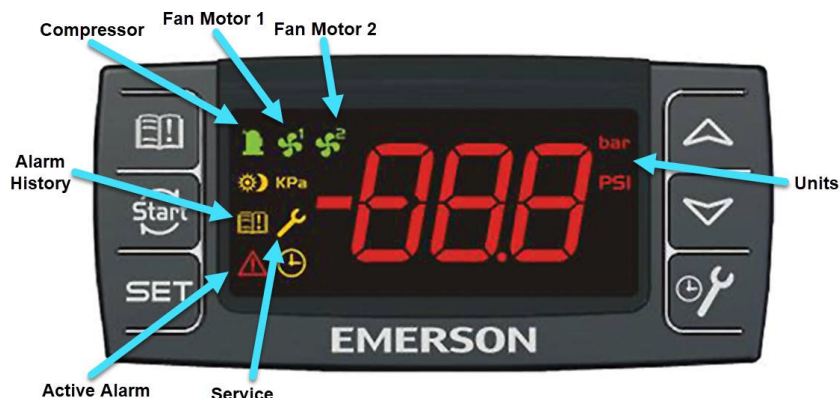









Figure 3 Controller Display

Table 1 LED Descriptions

LED	Mode	Function
	ON	Compressor on
	Flashing	Anti-short cycle delay enabled
	ON	Fan 1 on
	ON	Fan 2 on
PSI	ON	Pressures displayed in PSIG
PSI	Flashing	Programming mode
	ON	Browsing service menu
	Flashing	New alarm indication
	ON	Browsing alarm menu
	ON	An alarm is occurring

2.3. Button Descriptions and Key Combinations

Table 2 lists the different buttons on the controller (See **Figure 3**) and their functions. Table 3 lists the different key combinations and their functions.

Table 2 Button Descriptions









Button	Description
SET	Displays set point. In programming mode, it confirms an operation.
	When held for 3 seconds, it overrides cut-in value and starts compressor. When DLL or HPL lockout condition occurs, it resets lockout condition when held for 3 seconds 2 consecutive times (if temperatures or pressures exceed cut-out trip point values, pressing this button will not clear the fault).
 (UP)	Displays current condenser temperature. In programming mode, it browses parameters or increases the displayed parameter value.
 (DOWN)	Displays current discharge temperature. In programming mode, it browses parameters or decreases the displayed parameter value.
 Alarm Menu	Enters Alarm menu (See Section 3).
 SERVICE Menu	Enters SERVICE menu (See Section 4).

Table 3 Key Combinations

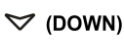
Key Combinations	
	Locks and unlocks the keypad.
SET + 	Enters programming mode.
SET + 	Returns to suction pressure display.

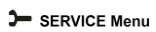
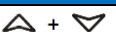
2.4. Viewing Temperature Readings





1. Press  button to view condenser temperature.
2. Press  button to view discharge temperate.

2.4.1. Viewing Setpoints

1. Press and immediately release **SET** button: the display will show the “ $\llbracket \text{r} \rrbracket$ ” message.
2. Press **SET** button to see the setpoint value.
3. Press and immediately release **SET** button: the display will show the “ $\llbracket \text{d} \rrbracket$ ” message.
4. Press **SET** button to see the setpoint value.

2.5. Changing a Parameter Value

To change a parameter value, do the following:

1. Hold down **SET** +  keys for 3 seconds, or until the “PSI” LED starts blinking, to enter the Programming Menu.
2. Press  or  button to select the required parameter. Press **SET** button to display parameter value.
3. Press  or  button to change parameter value.
4. Press **SET** button to store the new parameter value.

TO EXIT: Press **SET** +  keys or wait up to 30 seconds without pressing a button or key.

NOTE: The set value is stored, even when the procedure is exited, by waiting for the time-out to expire.





2.6. Entering the Advanced Options Menu

The Advanced Options Menu will be locked 5 minutes after the controller is powered. If access to the Advanced Options Menu is needed, cycle power to the controller.

1. Hold down **SET** +  keys for 3 seconds, or until the “PSI” LED starts blinking, to enter the Programming Menu.

2. Release keys, then hold down **SET** +  keys again for at least 7 seconds. The “ $\text{Pr} \llbracket \rrbracket$ ” label will be displayed immediately followed by the “ $\llbracket \text{r} \rrbracket$ ” parameter.

NOTE: THIS IS THE ADVANCE OPTIONS MENU.

3. Press  or  button to select the required parameter.
4. Press **SET** button to display parameter value.
5. Press  or  button to change parameter value.
6. Press **SET** button to store the new parameter value.

TO EXIT: Press **SET** +  keys or wait up to 30 seconds without pressing a button or key.

NOTE: If no parameter is present in “ $\text{Pr} \text{!}$ ” after 3 seconds, the controller will display the “ nop ” message. Keep the keys pushed until the “ $\text{Pr} \llbracket \rrbracket$ ” message is displayed.

NOTE: The set value is stored, even when the procedure is exited, by waiting for the time-out to expire.

2.6.1. Moving Parameters between Programming Menu and Advanced Options Menu

While in the Advanced Options Menu, certain parameters will have a period between the 2nd and 3rd characters. For example: “ $\llbracket \text{r} \rrbracket$ ”. These parameters are in both the Programming and Advanced Options menus.

To add or remove a parameter from the Programming Menu, do the following:



1. Enter the Advanced Options Menu and select the required parameter (See [Section 2.6](#), steps 1 through 3).
2. With the required parameter displayed, press **SET** +  keys.

NOTE: A period will be added or removed between the 2nd and 3rd characters of the selected parameter.

TO EXIT: Press **SET** +  keys or wait up to 30 seconds without pressing a button or key

2.6.2. Programming Using a Hotkey

Hotkeys (part # 943-0019-00) can be used to store the user's custom parameters. To upload parameters to a hotkey, do the following:

1. Turn controller ON.
2. Ensure controller is programmed as desired.
3. Disconnect 5-pin harness from rear of controller (See **Figure 4**).
4. Insert hotkey into 5-pin receptacle on rear of controller (See **Figure 4**).
5. Press  +  keys; controller will blink "UPL" and then display the "End" message.
6. Press **SET** button; "End" message will disappear.
7. Turn controller OFF.
8. Remove hotkey from rear of controller (See **Figure 4**).
9. Connect 5-pin harness to rear of controller (**Figure 4**).
10. Turn controller ON.

NOTE: If controller displays an "Err" message, programming has failed. Repeat steps 1-9 to restart upload process. Remove hotkey to abort.

To program controller using a hotkey, do the following:

1. Turn controller OFF.

2. Disconnect 5-pin harness from rear of controller (See **Figure 4**).
3. Insert pre-programmed hotkey into 5-pin receptacle on rear of controller (See **Figure 4**).
4. Turn controller ON.

NOTE: The download is successful when the following happens:

- a. Controller blinks "dOL" and displays "End." message.
- b. After 10 seconds, the controller goes back to the default display (suction pressure).
- c. Remove hotkey from rear of controller (See **Figure 4**).
- d. Connect 5-pin harness to rear of controller (See **Figure 4**).



NOTE: If controller displays an "Err" message, programming has failed. Cycle power to controller to restart download process. Remove hotkey to abort.

2.7. Locking the Keypad

1. Press  +  keys for more than 3 seconds.

NOTE: Controller will display "PDF" message when keypad is locked. While keypad is locked, only set points can be viewed. If a key is pressed for more than 3 seconds, controller will display "PDF" message.

2.8. Unlocking the Keypad

1. Press  +  keys for more than 3 seconds, until controller displays "POn" message.



5-pin harness connected

Hotkey connected





HotKey
Part# 943-0019-00



Figure 4 Programming Using a Hotkey

2.9. Resetting Alarm and Runtime Counters

See [Sections 3](#) and [4](#) for more information on Alarm and Service menus. The Advanced Options Menu will be locked for 5 minutes after the controller is powered. If counters need to be reset during this time, cycle power to the controller.

1. Hold down **SET** +  keys for 3 seconds, or until the “PSI” LED starts blinking, to enter the Programming Menu.
2. Release keys, then hold down **SET** +  keys again for at least 7 seconds. The “Prē” label will be displayed immediately followed by the “[_ n” parameter.

NOTE: THIS IS THE ADVANCED OPTIONS MENU.

3. Press  or  button to select the required parameter, listed below:

r5A- Reset Alarm Counters (HP, dLt, and Loc)

r[A - Reset Compressor Starts Counters

r[H - Reset Compressor Run Hours Counters

rFH - Reset Fan Run Hours Counters

4. Press **SET** button to display counter values.
5. Press  button to change “n” to “[_”
6. Press **SET** button to store new value and reset counter.
7. Repeat steps 3 through 6 to reset other counters.

3. Alarm Menu

The controller records the activations of the following alarms in the Alarm menu:

- High pressure trips (up to 999) - HP
- High DLT temperature alarm (up to 999) - dLt
- Total number of manual restarts (HPL and dLL) (up to 255) - Loc

To view alarm counters, do the following:

1. Press and release the  button; controller will display the “HP” label.
2. With controller displaying the “HP” label, press **SET** button to see the number of high pressure trips.
3. With controller displaying the “dLt” label, press **SET** button to see the number of DLT trips.
4. With controller displaying the “Loc” label, press **SET** button to see the number of manual resets.

4. Service Menu

The controller stores the following values in the SERVICE menu:

- **Number of compressor starts:**

5tH (0-999; resolution 1,000);

5tL (0-999; resolution 1) -

Example: If 5tH = 12 and 5tL = 500:

Total number of compressor starts = 12,500

- **Compressor run hours:**

[HH (0-65; resolution 1,000);

[HL (0-999; resolution 1) -

Example: If [HH = 8 and [HL = 500:

Total number of compressor run hours = 8,500

- **Fan motor 1 run hours:**

F1H (0-65; resolution 1,000);

F1L (0-999 resolution 1)

- **Fan motor 2 run hours:**

F2H (0-65; resolution 1,000);

F2L (0-999 resolution 1)

To view service counters, do the following:

1. Hold down  button for 3 seconds.
2. Press **SET** button to view selected service counters. See the above list for counter names and meanings.

5. Parameter List

All parameters and their descriptions, default values, and operating ranges are listed in **Table 4** and **Table 5**. Depending on the condensing unit model, some parameter values may be different than shown or not applicable.

Table 4 Parameters

Label	Description	Default	Range
Default Display Value			
	Current Suction Pressure (PSIG)		
Adjustable In Programming Menu			
C_{in}	Compressor cut-in (PSIG)	25	$C_{oU} - U5$
C_{oU}	Compressor cut-out (PSIG)	15	$L5 - C_{in}$
Adjustable From Advanced Options Menu			
$od5$	Outputs delay at start up (seconds) (Only adjustable on single phase scroll units)	2 or 4	2 - 255
RC	Anti-short cycle delay (Minimum time between compressor off then on) (seconds)	6	6 - 900
C_{on}	Compressor ON time with faulty probe (minutes)	5	0 - 255
C_{oF}	Compressor OFF time with faulty probe (minutes)	5	0 - 255
P_{IF}	Suction Pressure Transducer Offset (PSI)	0	- 120 - 120
b_{nP}	Bump start enabled	no	no - YES
nPS	Number of activations of DLT alarm in a hour to lock compressor (Units with discharge line temperature protection only)	4	0- 15; 0 = always automatic restart
HP_n	UL safety digital input activation before compressor lock (Units with fixed high pressure controls only)	5	0- 15; 0 = always automatic restart
$SF1$	Fan 1 Cut-out (°F) (Fan cycling units only)	70	-40 - $SF2$
$HF1$	Fan 1 differential (°F) (Fan cycling units only)	10	1 - 100
$SF2$	Fan 2 Cut-out (°F) (Fan cycling units only)	85	$SF1 - 230$
$HF2$	Fan 2 differential (°F) (Fan cycling units only)	15	1 - 100
r_{SA}	Reset Alarm Counters (HP , dLT , and L_{oc})		
r_{CR}	Reset Compressor Starts Counters		
r_{CH}	Reset Compressor Run Hours Counters		
r_{FH}	Reset Fan Run Hours Counters (Fan cycling units only)		
L_{RP}	Pressure to end time		- 15 to C_{oU}
$L_{\bar{O}}$	Minimum on time		0 to 15 (minutes)

Table 5 Factory Set Parameters

Label	Description	Default	Range
Factory Set Definitions			
L5	Minimum set point (PSIG)	-7 or 5	-7 - 45
U5	Maximum set point (PSIG)	135	L5 - 135
ono	Minimum time between two compressor starts (minutes)	0	0 - 15
nFR	Number of fans on during probe fault	2	0 - 2
Unit	Measurement unit for pressure: PSIG, bar, kPA	PSI	PSI, bar, HPA
[F	Measurement unit for temperature	F	C or F
on	Bump Start Compressor on time (seconds)	2	1 - 15
oFF	Bump Start Compressor off time (seconds)	5	1 - 15
nUb	Number of cycles during bump start	3	1 - 15
bEn	Compressor stop time for next bump start (hours)	4.0	1.0 - 23.5
doF	DLT alarm temperature to stop compressor (°F)	220	don - 302
don	DLT temperature for compressor restart (°F)	170	-58 - doF
RLd	DLT stop compressor delay (seconds)	0-5	0 - 255
dLF	Minimum time of compressor off with dLL alarm (minutes)	0	0 - 15
AU2	Cut-in for Condenser Temperature/Pressure alarm (°F)	150	AH2 - 230
AH2	Cut-out for high Condenser Temperature/Pressure alarm (°F)	140	-40 - AU2
Rd2	High condenser temperature alarm delay (minutes)	0	0 - 255
HPF	Minimum off time after a High-Pressure Trip (minutes)	5	0 - 15
P1i	Start scale for probe 1 (PSIG)	-15	-15 to P1E
P1E	End scale for probe 1 (PSIG)	135	P1i to 999
P1d	P1 alarm display delay, with P1C=0-5V (min)	0	0 - 100
P2P	Probe 2 presence		YES, n0
P2C	Probe 2 configuration		nLC, 0-5
P2i	Start scale for probe 2 (PSIG)	-15	-15 to P2E
P2E	End scale for probe 2 (PSIG)	485	P2i to 999
P3C	Probe 3 configuration		nU, dLt, CPA
Rb2	High condenser temperature alarm with compressor off		YES, no
oR1	AUX1 configuration		FRn, Fn2, RLr
oR2	AUX2 configuration		FRn, Fn2, RLr

6. Controller Wiring



Always disconnect and lockout the power supply before beginning electrical installations or troubleshooting.

6.1. Non-Fan Cycling Wiring Schematic

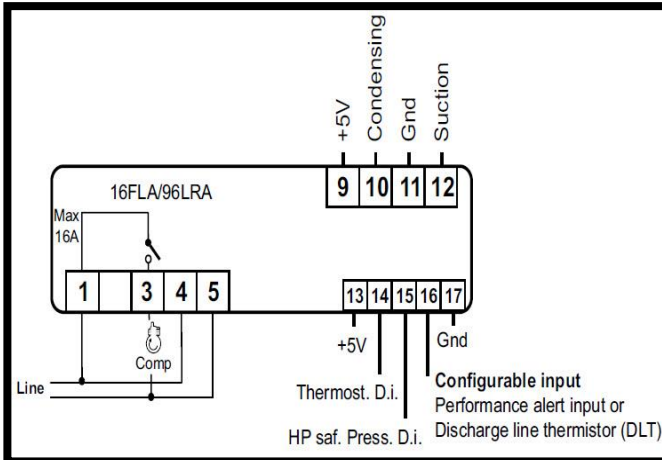

Figure 5 Non-Fan Cycling Wiring Schematic

Compressor: Use terminals 1-3.

Power Supply: Use terminals 4-5 (terminals 4 and 5 are for power supply at 110VAC or 230VAC, depending on the model).

Suction Pressure Transducer: Use terminal 9 (+5V) for supply, terminal 11 for ground, and terminal 12 for signal.

Condenser Temperature Sensor: Connect probe to terminal 11 (ground) and 10.

Thermostat Digital Input: Use terminals 14-17.

UL HP input: Use terminals 15-17.

DLT Sensor: Connect probe to terminals 16-17.

Copeland PerformanceAlert (CPA): See Figure 7.

6.2. Fan Cycling Wiring Schematic

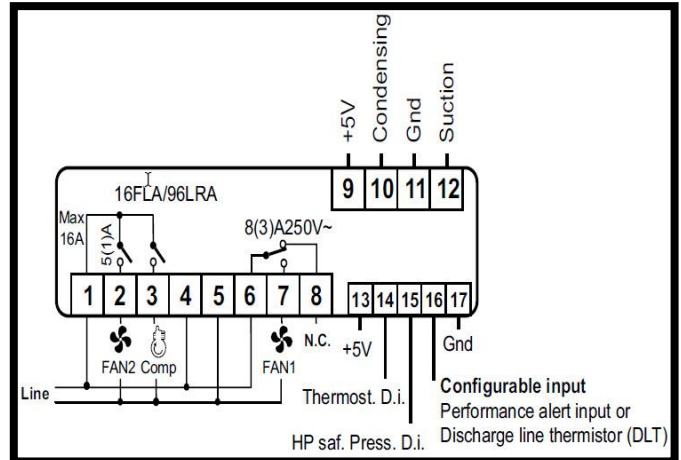

Figure 6 Fan Cycling Wiring Schematic

Compressor: Use terminals 1-3.

Power Supply: Use terminals 4-5 (terminals 4 and 5 are for power supply at 110VAC or 230VAC, depending on the model).

FAN 1: Use terminals 6-7.

FAN 2: Use terminals 1-2.

Suction Pressure Transducer: Use terminal 9 (+5V) for supply, terminal 11 for ground, and terminal 12 for signal.

Condenser Temperature Sensor: Connect probe to terminal 11 (ground) and 10.

Thermostat Digital Input: Use terminals 14-17.

UL HP input: Use terminals 15-17.

DLT Sensor: Connect probe to terminals 16-17.

Copeland PerformanceAlert (CPA): See Figure 7.

6.3. Copeland PerformanceAlert Connection

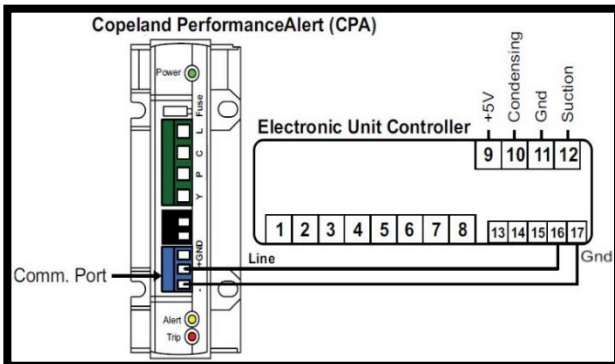

Figure 7 Wiring Schematic Example for Controller with Copeland PerformanceAlert

Copeland PerformanceAlert (CPA) connection: Use terminals 16-17. Connect the CPA as shown in **Figure 7**. For more information on PerformanceAlert, see Application Engineering Bulletin [AE8-1347](#).

6.4. Additional Controller Inputs

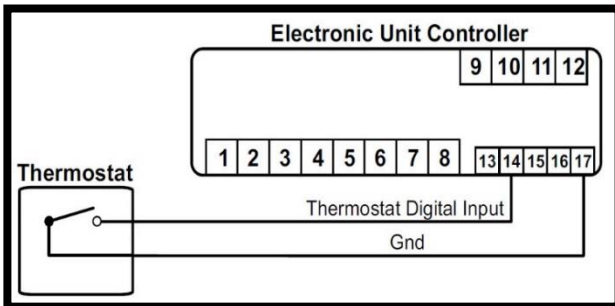

Figure 8 Wiring Schematic Example for Optional Thermostat

If another device, such as a thermostat, will be used to control the condensing unit, terminals 14 and 17 need to be connected to a dry contact (no voltage) on that control device (see **Figure 8**). Condensing units from the factory are configured for no thermostat, so pins 14 and 17 are tied together (see **Figure 13**). To use a thermostat, separate this jumper and connect the dry contact of the thermostat between the two wires. The polarity of the thermostat input is CLOSED for cooling and OPEN for no cooling.

Terminals 14 and 17 are located on the hotkey cable and will be connected together by push-on type connectors. See **Figure 5**, **Figure 6**, **Figure 7**, and **Figure 8** for wiring details.

NOTE: If using a control (e.g., thermostat) with another device (e.g., pump down solenoid), no connections to the controller are required.

7. Alarms and Notifications

In the event of an issue or fault, the codes listed below will flash to indicate the alarm condition. See [Section 9](#) for troubleshooting information.

Table 6 Alarms and Notifications

Code	Description
<i>P_oF</i>	Keypad locked
<i>P_on</i>	Keypad unlocked
<i>P₁</i>	Suction probe failure
<i>P₂</i>	Condenser probe failure
<i>P₃</i>	DLT probe failure
<i>H_R</i>	High condenser temperature alarm
<i>d_Lt</i>	DLT temperature alarm
<i>d_LL</i>	DLT lock alarm
<i>H_P</i>	High-pressure trip alarm
<i>H_PL</i>	High-pressure trip lockout alarm
<i>[CPA]</i>	Copeland PerformanceAlert not connected properly
<i>EE</i>	Electronic Unit Controller failure
<i>[C]H</i>	Compressor working hour counter alarm
<i>FH</i>	Fan working hour counter alarm
<i>HdL</i>	Maximum alarm count has been reached - alarm counters need to be reset

If a Copeland PerformanceAlert* module is installed in the unit, PerformanceAlert error codes will be displayed on the controller screen. This eliminates the need to count lights flashed on the PerformanceAlert module itself. For more information on PerformanceAlert, see Application Engineering Bulletin [AE8-1347](#).

Table 7 Copeland PerformanceAlert Error Codes

Code	Three Phase Recip.	Three Phase Scroll	Single Phase
E01	Discharge Temperature Trip	Discharge Temperature Trip	Discharge Temperature Trip
E02	System Trip	System Trip	System Trip
E03	Short Cycling	Short Cycling	Short Cycling
E04	Locked Rotor	Locked Rotor	Locked Rotor
E05	Open Circuit	Open Circuit	Open Circuit
E06	Missing Phase	Missing Phase	Missing Phase
E07	N/A	Reverse Phase	Open Run
E08	Welded Contactor	Welded Contactor	Welded Contactor
E09	Low Voltage	Low Voltage	Low Voltage
E10	Lost Communications	Lost Communications	Lost Communications
E11	DLT Sensor Failure	DLT Sensor Failure	DLT Sensor Failure

*Copeland PerformanceAlert is not replaced by the Electronic Unit Controller. The PerformanceAlert module includes many features not included in the Electronic Unit Controller, such as locked rotor protection, loss of phase, etc. The Electronic Unit Controller is able to interface with PerformanceAlert to display error codes in an easy-to-read format.

7.1. Discharge Line Temperature Protection

The Electronic Unit Controller uses a temperature sensor, which allows for more flexibility in what the controller can do. If the unit trips, the unit will display an error code and log that an error has occurred. In addition, the controller will allow an automatic reset up to 4 times per hour. On the fourth trip, the controller will require a manual reset. The parameter “nPS” can be changed in the Advanced Options Menu (see [Section 2.6](#)) to adjust the total number of trips allowed in an hour before a lockout. If an automatic reset is always needed, parameter “nPS” can be set to 0.

Controllers built in September 2015 and after are programmed with a higher discharge line cut-out temperature and a 5 second trip delay, reducing nuisance trips.

NOTE: If nuisance trips are occurring on controllers built before September 2015 (15I date code), contact application engineering for support.

Controllers built before September 2015:

Default Discharge Line Cut-in Temp:	170°F
Default Discharge Line Cut-out Temp:	220°F
Trip Delay:	N/A

Controllers built September 2015 and after:

Default Discharge Line Cut-in Temp:	170°F
Default Discharge Line Cut-out Temp:	225°F
Trip Delay:	5 seconds

7.2. UL High Pressure Safety Control

High-pressure control is a UL (Underwriters Laboratories) safety device. As such, Emerson Climate Technologies condensing units equipped with the

Electronic Unit Controller still come with the high-pressure mechanical control installed on the unit. The high-pressure controls are fixed to work with the control, and the value of the cut-out is determined by the working pressure of the high side of the condensing unit. This should have no effect on a customer's UL requirements.

The high-pressure control breaks power to the compressor output relay, which shuts down the compressor regardless of the program state. This allows the controller to read the high-pressure control state and display the appropriate error codes. In addition, the controller allows an automatic reset up to 4 times per hour. On the fifth trip, the controller requires a manual reset. The parameter "HP_n" can be changed in the Advanced Options Menu (See [Section 2.6](#)) to adjust the total number of trips allowed in an hour before a lockout. If an always automatic reset is needed, parameter "HP_n" should be set to 0.

8. Electronic Unit Controller Replacement

⚠ WARNING

Electronic Unit Controller replacement must be performed in accordance with safety instructions. Disconnect and lockout power before servicing. See **Safety** section for additional information.

8.1. Silver Electrical Box Applications



Figure 9 Silver Electrical Box

1. Disconnect main power source.
2. Remove electrical box cover.
3. Remove Electronic Unit Controller assembly and rotate it up 90 degrees. The assembly should now

slide and clip onto the top of the electrical box, leaving the wiring harnesses exposed.

4. Disconnect three wiring harnesses from rear of controller.
5. Verify replacement controller and existing controller have the same part number (e.g., part number: 543-0133-00).

NOTE: A controller with a part number ending in -00 may be replaced with a controller with a part number ending in -01 or -02 (See [Section 8.5](#)).

6. Insert replacement controller through the slot. Ensure controller wiring schematic is pointing away from the operator.
7. Connect three wiring harnesses to rear of controller. Ensure the part number on the blue harness is facing towards the operator.
8. Unclip Electronic Unit Controller assembly from the top of the electrical box and slide it back into its original position.
9. Install electrical box cover.
10. Connect main power source.
11. Set controller parameters to match values listed on inside label (See [Section 8.4](#)).

8.2. Small Black Electrical Box Applications



Figure 10 Small Black Electrical Box

1. Disconnect main power source.
2. Remove electrical box cover.
3. Bend the metal tabs on either side of the controller outward and pull controller approximately halfway out.

4. Disconnect three wiring harnesses from rear of controller.
5. Completely remove controller from assembly.
6. Verify replacement controller and existing controller have the same part number (e.g., part number: 543-0133-00).
NOTE: A controller with a part number ending in -00 may be replaced with a controller with a part number ending in -01 or -02 (See [Section 8.5](#)).
7. Bend the metal tabs on either side of the empty slot inward prior to installing replacement controller.
8. Insert replacement controller through the slot with label facing away. Push controller halfway in.
9. Connect three wiring harnesses to rear of controller. Ensure controller wiring schematic is pointing away from the operator.
10. Finish installing replacement controller in assembly.
11. Install electrical box cover.
12. Connect main power source.
13. Set controller parameters to match values listed on inside label (See [Section 8.4](#)).

8.3. Plastic Retainer Applications (Large Black Electrical Box and X-Line Units)



Figure 11 Large Black Electrical Box

1. Disconnect main power source.
2. Remove electrical box cover.
3. Disconnect three wiring harnesses from rear of controller.



4. Press the centers of the white plastic connectors and pull them straight out.
5. Remove controller.
6. Verify replacement controller and existing controller have the same part number (e.g., part number: 543-0133-00).
NOTE: A controller with a part number ending in -00 may be replaced with a controller with a part number ending in -01 or -02 (See [Section 8.5](#)).
7. Insert replacement controller through the slot. Ensure controller wiring schematic is facing up.
8. Secure controller with white retainer clips.
9. Connect three wiring harnesses to rear of controller. Ensure part label on blue wiring harness is facing down.
10. Install electrical box cover.
11. Connect main power source.
12. Set controller parameters to match values listed on inside label (See [Section 8.4](#)).

8.4. Setting Controller Parameters After Replacement



Control settings vary for each condensing unit model. The replacement controller must be programmed for the condensing unit to function properly.

See the provided programming instruction label (052-7272-00) or wiring schematic (X-Line units only) for a list of default parameter values.

To program a replacement controller with default parameter values, do the following:

1. Hold down **SET** +  keys for 3 seconds, or until the “PSI” LED starts blinking, to enter the Programming Menu.
2. Release keys, then hold down **SET** +  keys again for at least 7 seconds. The “P_r2” label will be displayed immediately followed by the “[_ n” parameter.

NOTE: THIS IS THE ADVANCED OPTIONS MENU.

3. Press  or  button to select the required parameter.
4. Press **SET** button to display parameter value.
5. Compare displayed values with the values on the provided label (See **Figure 12**).

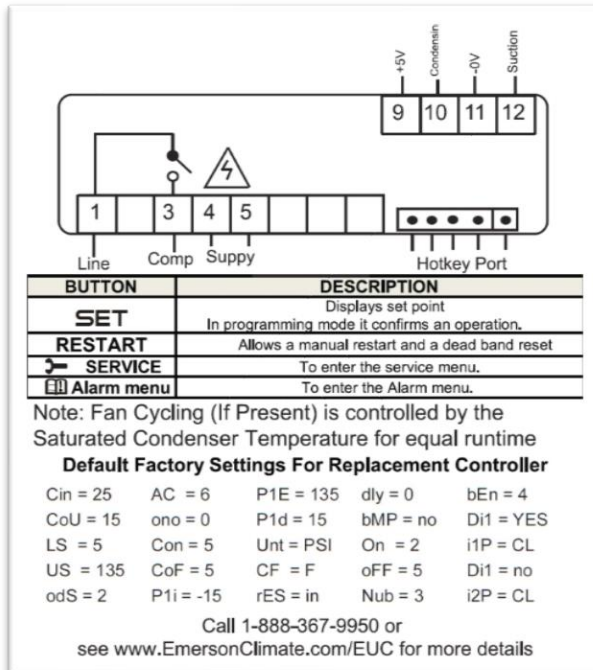





Figure 12 Example of Default Parameters and Schematic on Inside Label

6. Press  or  button to change parameter value, if needed.
7. Press **SET** button to store the new parameter value, if needed.
8. Repeat steps 3 through 7 as needed to complete the process.

TO EXIT: Press **SET** +  keys or wait 15 seconds without pressing a button or key.

8.5. Replacing -00 Controller with -01 or -02 Controller

1. Check to see if there is a blue wire in the jumper cable (See **Figure 13**).

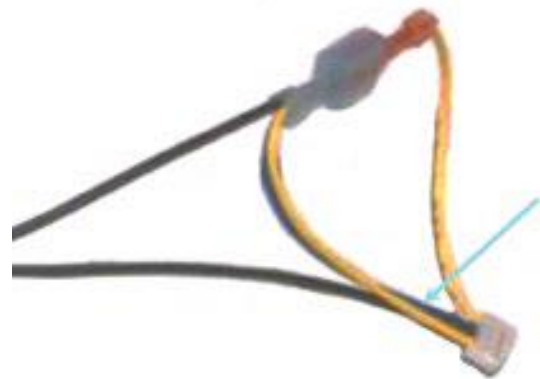

Figure 13 Jumper Cable with Blue Wire

- If blue wire is present, continue with controller replacement.
- If blue wire is not present, use the jumper cable supplied with the replacement controller kit and continue with controller replacement.

NOTE: If the jumper cable without a blue wire is not replaced, replacement controller will flash “HP” error code and will not operate.

NOTE: The replacement jumper cable includes a discharge line temperature probe. If condensing unit is not equipped with discharge temperature protection, secure discharge line temperature probe to jumper cable using a cable tie.

9. Thermistor Temperature/Resistance Values for Condenser Temperature Sensor

Deg °C	Deg °F	Resistance (kOhms)	Deg °C	Deg °F	Resistance (kOhms)	Deg °C	Deg °F	Resistance (kOhms)	Deg C	Deg °F	Resistance (kOhms)
-50	-58	329.5	-8	18	38.77	34	93	7.192	76	169	1.869
-49	-56	310.9	-7	19	37.06	35	95	6.94	77	171	1.816
-48	-54	293.5	-6	21	35.44	36	97	6.699	78	172	1.765
-47	-53	277.2	-5	23	33.9	37	99	6.467	79	174	1.716
-46	-51	262	-4	25	32.44	38	100	6.245	80	176	1.668
-45	-49	247.7	-3	27	31.05	39	102	6.032	81	178	1.621
-44	-47	234.3	-2	28	29.73	40	104	5.827	82	180	1.577
-43	-45	221.7	-1	30	28.48	41	106	5.629	83	181	1.533
-42	-44	209.9	0	32	27.28	42	108	5.438	84	183	1.491
-41	-42	198.9	1	34	26.13	43	109	5.255	85	185	1.451
-40	-40	188.5	2	36	25.03	44	111	5.08	86	187	1.411
-39	-38	178.5	3	37	23.99	45	113	4.911	87	189	1.373
-38	-36	169	4	39	23	46	115	4.749	88	190	1.336
-37	-35	160.2	5	41	22.05	47	117	4.593	89	192	1.3
-36	-33	151.9	6	43	21.15	48	118	4.443	90	194	1.266
-35	-31	144.1	7	45	20.3	49	120	4.299	91	196	1.232
-34	-29	136.7	8	46	19.48	50	122	4.16	92	198	1.2
-33	-27	129.8	9	48	18.7	51	124	4.026	93	199	1.168
-32	-26	123.3	10	50	17.96	52	126	3.896	94	201	1.137
-31	-24	117.1	11	52	17.24	53	127	3.771	95	203	1.108
-30	-22	111.3	12	54	16.56	54	129	3.651	96	205	1.079
-29	-20	105.7	13	55	15.9	55	131	3.536	97	207	1.051
-28	-18	100.5	14	57	15.28	56	133	3.425	98	208	1.024
-27	-17	95.52	15	59	14.69	57	135	3.318	99	210	0.9984
-26	-15	90.84	16	61	14.12	58	136	3.215	100	212	0.9731
-25	-13	86.43	17	63	13.58	59	138	3.116	101	214	0.9489
-24	-11	82.26	18	64	13.06	60	140	3.02	102	216	0.9246
-23	-9	78.33	19	66	12.56	61	142	2.927	103	217	0.9014
-22	-8	74.61	20	68	12.09	62	144	2.838	104	219	0.8789
-21	-6	71.1	21	70	11.63	63	145	2.751	105	221	0.8572
-20	-4	67.77	22	72	11.2	64	147	2.668	106	223	0.836
-19	-2	64.57	23	73	10.78	65	149	2.588	107	225	0.8155
-18	0	61.54	24	75	10.38	66	151	2.511	108	226	0.7956
-17	1	58.68	25	77	10	67	153	2.436	109	228	0.7763
-16	3	55.97	26	79	9.632	68	154	2.364	110	230	0.7576
-15	5	53.41	27	81	9.281	69	156	2.295			
-14	7	50.98	28	82	8.944	70	158	2.228			
-13	9	48.68	29	84	8.622	71	160	2.163			
-12	10	46.5	30	86	8.313	72	162	2.1			
-11	12	44.43	31	88	8.014	73	163	2.039			
-10	14	42.47	32	90	7.728	74	165	1.98			
-9	16	40.57	33	91	7.454	75	167	1.924			

9.1. Thermistor Temperature/Resistance Values for Discharge Temperature Sensor

Deg °C	Deg °F	Resistance (kOhms)
-40	-40	2889.6
-35	-31	2087.22
-30	-22	1522.2
-25	-13	1121.44
-20	-4	834.72
-15	5	627.28
-10	14	475.74
-5	23	363.99
0	32	280.82
5	41	218.41
10	50	171.17
15	59	135.14
20	68	107.44
25	77	86
30	86	69.28
35	95	56.16
40	104	45.81
45	113	37.58
50	122	30.99
55	131	25.68
60	140	21.4
65	149	17.91
70	158	15.07
75	167	12.73

Deg °C	Deg °F	Resistance (kOhms)
80	176	10.79
85	185	9.2
90	194	7.87
95	203	6.77
100	212	5.85
105	221	5.09
110	230	4.45
115	239	3.87
120	248	3.35
125	257	2.92
130	266	2.58
135	275	2.28
140	284	2.02
145	293	1.8
150	302	1.59
155	311	1.39
160	320	1.25
165	329	1.12
170	338	1.01
175	347	0.92
180	356	0.83

10. Measuring Pressure/Voltage Values for Suction Pressure Transducer

To measure voltage to the suction pressure transducer manually, do the following:

1. Turn controller ON.
2. Monitor current suction pressure on controller display (See [Section 2.2](#)) and record reading.
3. Using a voltmeter, measure the voltage on the green-block-plug wiring connections located on rear of controller (See **Figure 14**).

Pin 9 Red wire (+5VDC) supply voltage from the controller to the transducer.

Pin 11 Black wire (ground)

Pin 12 Blue wire. Feedback voltage from the transducer to the controller.

4. Using the table below, compare the PSI indicated by the measured voltage between pins 11 and 12 to the suction pressure displayed on the controller.

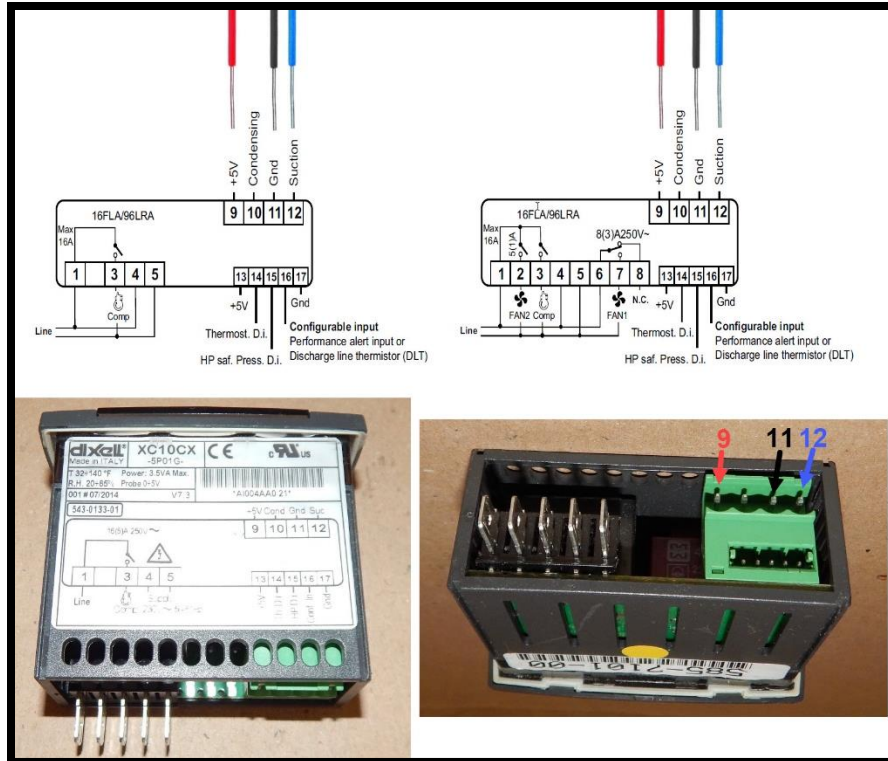

Figure 14 Measuring Suction Pressure Transducer Voltage

DC Voltage	PSI
0.5	-15
0.6	-11.3
0.7	-7.5
0.8	-3.8
0.9	0
1	3.8
1.1	7.5
1.2	11.3
1.3	15
1.4	19
1.5	23
1.6	26
1.7	30
1.8	34
1.9	38
2	41
2.1	45

DC Voltage	PSI
2.2	49
2.3	53
2.4	56
2.5	60
2.6	64
2.7	68
2.8	71
2.9	75
3	78.8
3.1	82.5
3.2	86.3
3.3	90
3.4	93.8
3.5	97.5
3.6	101.3
3.7	105

DC Voltage	PSI
3.8	108.8
3.9	112.5
4	116.3
4.1	120
4.2	123.8
4.3	127.5
4.4	131.3
4.5	135

11. Troubleshooting Guide

Display	Likely Causes	Other Possible Causes
Controller display remains blank after applying power.	<ul style="list-style-type: none"> • Unit power not properly applied – check • Power cable harness not plugged in properly or securely into the back of the controller - check connections. 	<ul style="list-style-type: none"> • Power cable miswired – inspect cable; replace if needed. • Electrical assembly miswired – trace wiring diagrams.
Controller displays correctly, but the green compressor light is off and the compressor is not running.	<ul style="list-style-type: none"> • Jumper cable not plugged in properly or securely into the back of the controller – check connections • Controller is currently above the cut-in setting – check cut-in and cut-out settings 	<ul style="list-style-type: none"> • Jumper cable miswired – inspect cable; replace if needed.
Controller displays correctly, the green compressor light is on, and the compressor is not running	<ul style="list-style-type: none"> • Power cable harness not plugged in properly or securely into the back of the controller – check connections. 	<ul style="list-style-type: none"> • Power cable not wired to the contactor or compressor correctly – check wiring. • Power cable miswired – inspect cable; replace if needed.
Controller flashes “135” or “P1”	<ul style="list-style-type: none"> • Current system pressure above 135 PSIG – wait for system to pull down. • Green harness not plugged in properly or securely into the back of the controller – check connections. • Cable not connected properly with the pressure transducer – check connections. • Compressor is not running to pulldown suction pressure below 135 PSIG. 	<ul style="list-style-type: none"> • Transducer cable miswired – inspect cable; replace if needed. • Damaged transducer– inspect transducer DC voltage value against table in Section 10.; replace if needed. • After 15 minutes Standby system pressure is above 135 PSIG and compressor is not running to pulldown pressure a P1 alarm is shown.
Controller flashes “P2” on a unit with fan cycling	<ul style="list-style-type: none"> • Green harness not plugged in properly or securely into the back of the controller – check connections. 	<ul style="list-style-type: none"> • Transducer cable miswired – inspect cable; replace if needed. • Check condenser temperature sensor resistance values against table in Section 9.
Controller flashes “P2” on a unit without fan cycling after replacing a controller	<ul style="list-style-type: none"> • Controller not programmed properly – check parameters in Advanced Options Menu. 	<ul style="list-style-type: none"> • All EUC controller from the factory are factory set controller and need to be program base on the default factory settings of the replacement controller found on the EUC back electrical box cover.

Troubleshooting Guide (continued)

Display	Likely Causes	Other Possible Causes
Controller flashes “P3” on a unit with DLT	<ul style="list-style-type: none"> Jumper cable not plugged in properly or securely into the back of the controller – check connections. 	<ul style="list-style-type: none"> Jumper cable miswired – inspect cable; replace if needed. Faulty DLT temperature sensor – check discharge line temperature sensor resistance values against table in Section 9. Or Press the down arrow once to display the actual temperature reading of the DLT sensor. Check DLT temperature sensor location at compressor discharge line. Proper location is 6 inches away from compressor discharge line.
Controller flashes “P3” on a unit without DLT after replacing a controller	<ul style="list-style-type: none"> Controller not programmed properly – check parameters in Advanced Options Menu. 	<ul style="list-style-type: none"> All EUC controller from the factory are factory set controller and need to be program base on the default factory settings of the replacement controller found on the EUC back electrical box cover.
Fans not running on a fan cycling unit and the fan lights are not on	<ul style="list-style-type: none"> Mid coil condensing temperature currently below the fan cut-in settings. Condensing temperature sensor not properly installed – check installation. Fan cycling control are cycle ON and OFF base on the run time settings. <p>Note: SF1 value for cut-out temperature must be added deferential HF1 for the cut-in temperature settings for Fan 1. Apply the same rule to SF2 and HF2 for Fan 2.</p>	<ul style="list-style-type: none"> Transducer cable miswired – inspect cable; replace if needed. Faulty temperature sensor - check condenser temperature sensor resistance values against table in Section 9.

Troubleshooting Guide (continued)

Display	Likely Causes	Other Possible Causes
Fans not running on a fan cycling unit and the fan lights are on	<ul style="list-style-type: none"> Power cable harness not plugged in properly or securely into the back of the controller – check connections. 	<ul style="list-style-type: none"> Power cable miswired – inspect cable, replace if needed. Electrical assembly miswired – trace wiring diagrams.
Controller flashes “HP” at power-up	<ul style="list-style-type: none"> Jumper cable not plugged in properly or securely into the back of the controller – check connections. High-pressure switch seeing above the cut-out pressure. If replacing a -00 controller, ensure jumper cable is the latest revision. It should have a blue wire in the harness. See Section 8.5 for more details. 	<ul style="list-style-type: none"> Jumper cable miswired – inspect cable; replace if needed. Faulty fixed Hp switch – inspect switch; replace if needed. HP switch settings are: 440 PSI cut-out 325 PSI cut-in.
Controller flashes “HP” or “HPL”	<ul style="list-style-type: none"> System operation causing high discharge pressures – check system operations. 	<ul style="list-style-type: none"> Bad high-pressure switch – verify system pressure when the pressure switch trips. See Section 7.2 for more details.
Controller flashes “dLE” or “dLL”	<ul style="list-style-type: none"> System operation causing high discharge line temperatures – check system operations. 	<ul style="list-style-type: none"> Faulty temperature sensor - check DLT sensor values against table in Section 9. See Section 7.1 for more details. DLT maximum temperature settings is 225F.
Controller flashing “HPL” or “dLL”	<ul style="list-style-type: none"> System operation causing high discharge pressures (HPL) or high discharge line temperatures (DLL) repeatedly – check system operations. To clear an HPL or DLL lockout, hold the Start button for 3 seconds 2 consecutive times, or cycle power to the unit. If using the reset button, the alarm condition will have to clear (DLT temperature drops or Hp switch resets) and any minimum off time will need to complete (5 minutes for the fixed Hp switch). 	<ul style="list-style-type: none"> (HPL) high discharge pressures lock alarm is displayed if 5 repeatedly HP alarms occur within 1 hour. (DLL) high discharge line temperatures lock alarm is displayed if 4 repeatedly HP alarm occur within 1 hour.

12. Parts Kits

Kit	Part Number	Description	Qty
943-0152-00 115V Non Fan Cycling Controller	543-0132-00*/01/02	CONTROLLER	1
	529-0113-04	CABLE-SENSOR ASSM.	1
	032-7050-00	CLIP	2
	FM-2011IP-74	CONTROLLER FORM	1
943-0153-00 230V Non Fan Cycling Controller	543-0133-00*/01/02	CONTROLLER - ELECT UN	1
	529-0113-04	CABLE-SENSOR ASSM.	1
	032-7050-00	CLIP	2
	FM-2011IP-74	CONTROLLER FORM	1
943-0154-00 115V Fan Cycling Controller	543-0134-00*/01/02	CONTROLLER - ELECT UN	1
	529-0113-04	CABLE-SENSOR ASSM.	1
	032-7050-00	CLIP	2
	FM-2011IP-74	CONTROLLER FORM	1
943-0155-00 230V Fan Cycling Controller	543-0135-00*/01/02	CONTROLLER - ELECT UN	1
	529-0113-04	CABLE-SENSOR ASSM.	1
	032-7050-00	CLIP	2
	FM-2011IP-74	CONTROLLER FORM	1
929-0113-00 White Input Sensor Cable Kit with DLT Sensor 	529-0113-02	CABLE-SENSOR ASSM.	1
	529-0113-04	CABLE-SENSOR ASSM.	1
929-0114-00 Suction Pressure Transducer and Cables 	039-0026-06	TRANSDUCER - PRESSUR	1
	529-0114-00	CABLE-SENSOR ASSM.	1
	529-0114-01	CABLE-SENSOR ASSM.	1

*Old Electronic Unit Controller part number

Kit	Part Number	Description	Qty
929-0114-01 Suction Pressure Transducer Cable with Condenser Temperature Sensor	529-0114-01	CABLE-SENSOR ASSM.	1
943-0037-00 115V Non Fan Cycling Stand Alone Kit	543-0132-03	CONTROLLER - ELECT UN	1
	032-7050-00	CLIP	2
	529-0113-02	CABLE-SENSOR ASSM.	1
	529-0114-00	CABLE-SENSOR ASSM.	1
	039-0026-06	TRANSDUCER - PRESSUR	1
	AE8-1376 AE	BULLETIN	1
943-0037-01 230V Non Fan Cycling Stand Alone Kit	543-0133-03	CONTROLLER - ELECT UN	1
	032-7050-00	CLIP	2
	529-0113-02	CABLE-SENSOR ASSM.	1
	529-0114-00	CABLE-SENSOR ASSM.	1
	039-0026-06	TRANSDUCER - PRESSUR	1
	AE8-1376 AE	BULLETIN	1
943-0037-02 115V Pressure Based Fan Cycling Stand Alone Kit	543-0134-03	CONTROLLER - ELECT UN	1
	032-7050-00	CLIP	2
	529-0113-02	CABLE-SENSOR ASSM.	1
	529-0114-03	CABLE-SENSOR ASSM.	1
	039-0026-06	TRANSDUCER - PRESSUR	1
	039-0026-03	TRANSDUCER - PRESSUR	1
	AE8-1376 AE	BULLETIN	1
943-0037-03 230V Pressure Based Fan Cycling Stand Alone Kit	543-0135-03	CONTROLLER - ELECT UN	1
	032-7050-00	CLIP	2
	529-0113-02	CABLE-SENSOR ASSM.	1
	529-0114-03	CABLE-SENSOR ASSM.	1
	039-0026-06	TRANSDUCER - PRESSUR	1
	039-0026-03	TRANSDUCER - PRESSUR	1
	AE8-1376 AE	BULLETIN	1

Kit	Part Number	Description	Qty
962-0007-00 EUC Enclosure Kit	062-7048-01	BOX - ELECTRICAL	1
	005-7226-01	COVER - LID	1
	036-0275-00	FITTING - KNOCKOUT PLU	2
	100-0180-09	SCREW - HEX HD SELF TA	1

<p>943-0019-00 Hot Key</p> 

Supplier Numbers equivalence*			
Copeland Part Number	Dixell Part Number	Features	Voltage
543-0132-01 543-0132-02	XC10CX-4P0IG	Without fan cycling control	115V
543-0134-01 543-0134-02	XC30CX-4P0IG	With fan cycling control	
543-0133-01 543-0133-02	XC10CX-5P0IG	Without fan cycling control	230V
543-0135-01 543-0135-02	XC30CX-5P10G	With fan cycling control	

* Supplier equivalent parts don't include Copeland Parts settings.

13. For Service Only

Since July 2018, pressure transducer and cables 039-0026-06 replaced the legacy 039-0026-02 pressure transducer and cables. See **Figure 15** and **Figure 16** for a comparison between both parts.

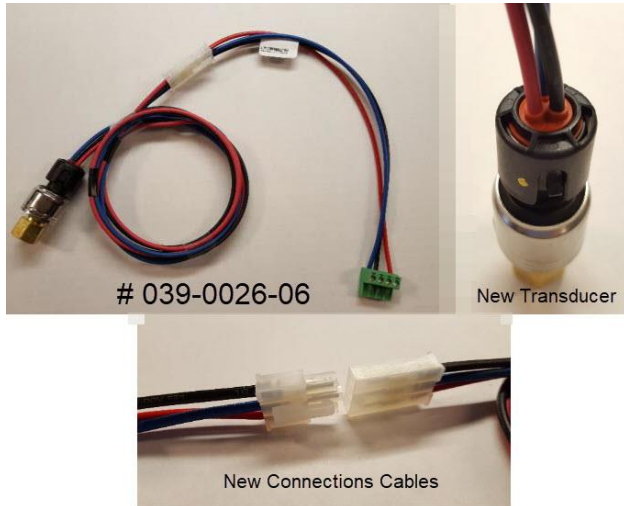

Figure 15 – Part # 039-0026-06 New pressure transducer and connection cable



Figure 16 – Part # 039-0026-02 Legacy pressure transducer and cables.

The contents of this publication are presented for informational purposes only and are not to be construed as warranties or guarantees, express or implied, regarding the products or services described herein or their use or applicability. Emerson Climate Technologies, Inc. and/or its affiliates (collectively "Emerson"), as applicable, reserve the right to modify the design or specifications of such products at any time without notice. Emerson does not assume responsibility for the selection, use or maintenance of any product. Responsibility for proper selection, use and maintenance of any Emerson product remains solely with the purchaser or end user.