

iPro HVAC and Lighting Installation and Operation Manual

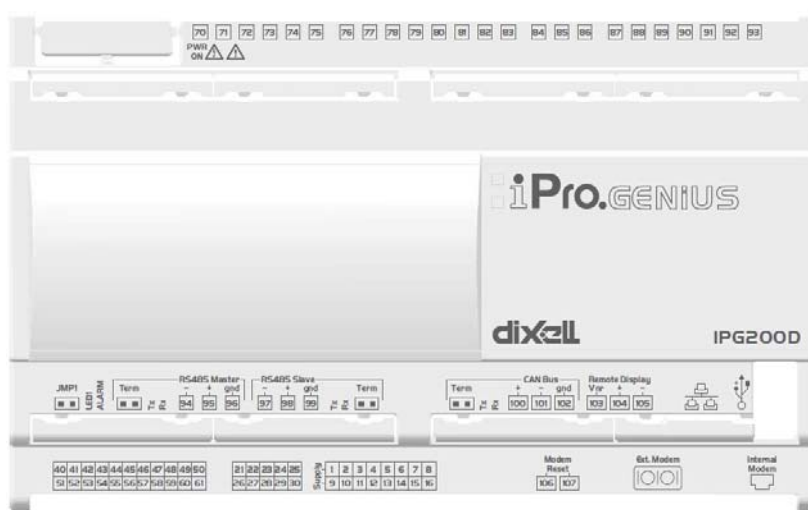



Retail Solutions
3240 Town Point Drive NW, Suite 100
Kennesaw, GA 30144

Phone: **770-425-2724**
Fax: 770-425-9319

Table Of Contents

1 INTRODUCTION.....	1
1.1. THE IPRO HVAC AND LIGHTING'S I/O POINTS	1
1.2. INDEPENDENT SYSTEM CONTROL	1
2 MOUNTING AND POWERING	2
2.1. INSTALLATION	2
2.1.1. <i>Specifications - Mounting and Electrical</i>	2
2.2. POWERING	2
2.2.1. <i>Choosing Transformer Sizes</i>	3
2.2.2. <i>Power Wiring</i>	3
2.2.3. <i>Wire Types and Maximum Distances</i>	3
3 NETWORK ADDRESSING - VISOGRAPH.....	4
3.1. CONNECTING THE VISOGRAPH	4
3.2. VISOGRAPH NAVIGATION	4
3.2.1. <i>Versions</i>	4
4 INPUT AND OUTPUT SETUP.....	5
4.1. WIRING ANALOG INPUTS	5
4.2. WIRING DIGITAL INPUTS	6
4.3. WIRING DIGITAL LOADS	8
4.4. WIRING ANALOG OUTPUTS	9
5 IPRO HVAC AND LIGHTING STATUS LEADS.....	11
6 SOFTWARE OVERVIEW	12
6.1. SCHEDULES.....	12
6.1.1. <i>Master Schedule Control</i>	12
6.1.2. <i>Slave Schedule Control</i>	13
6.2. LIGHTING CONTROL	13
6.2.1. <i>Lighting Control - Physical Inputs and Outputs</i>	13
6.2.2. <i>Inside Lighting Control</i>	14
6.2.2.1. Dimming Control.....	14
6.2.2.2. Schedule Only.....	14
6.2.2.3. Schedule and Light Level Combination	14
6.2.2.4. Logic Input.....	15
6.2.3. <i>Outside Lighting Control</i>	15
6.2.3.1. Light Level Control	15
6.2.3.2. Schedule Only.....	15
6.2.3.3. Schedule and Light Level Combination	15
6.2.3.4. Logic Input.....	15
6.3. HVAC CONTROL.....	15
6.3.1. <i>HVAC Control – Physical Inputs and Outputs-Default Setup</i>	16
6.3.2. <i>Cooling Control</i>	16
6.3.2.1. Monitoring and Lockout Temperatures	16
6.3.2.2. Control Temperature.....	16
6.3.2.3. Space Temperature Control and Setpoints.....	17
6.3.2.4. Cooling Control Strategy	18
6.3.3. <i>Heating Control</i>	18
6.3.3.1. Monitoring and Lockout Temperatures	18

6.3.3.2. Control Temperature.....	18
6.3.3.3. Space Temperature Control and Setpoints.....	18
6.3.3.4. Heating Control Strategy	19
6.3.3.5. Heat Pump Control	19
6.3.4. <i>Fan Control</i>	20
6.3.5. <i>Economizer Control</i>	21
6.3.5.1. Economizer Enable	21
6.3.5.2. Indoor Air Quality	22
6.3.5.3. Damper Control	22
6.4. ALARMS	22
6.5. iPRO HVAC AND LIGHTING FUNCTIONS.....	24
6.6. iPRO HVAC AND LIGHTING PARAMETERS.....	24
7 CONNECTIONS.....	39
7.1. iPRO HVAC AND LIGHTING CONNECTOR DESCRIPTIONS	39
7.2. TERMINAL NUMBER DESCRIPTIONS	40
7.3. TECHNICAL SPECIFICATIONS	42
7.3.1. <i>Analog Inputs</i>	42
7.3.2. <i>Digital Inputs</i>	42
7.3.3. <i>Analog Outputs</i>	43
7.3.4. <i>Digital Outputs</i>	43
7.4. WIRING	44
INDEX.....	46

1 Introduction

The iPro HVAC and Lighting controller (P/N 818-9004) is a lighting and HVAC control board standalone controller. iPro HVAC and Lighting is capable of controlling heat and cool stages, fans, and economizers using on-board I/O and control algorithms. The iPro HVAC and Lighting supports local physical inputs and outputs.

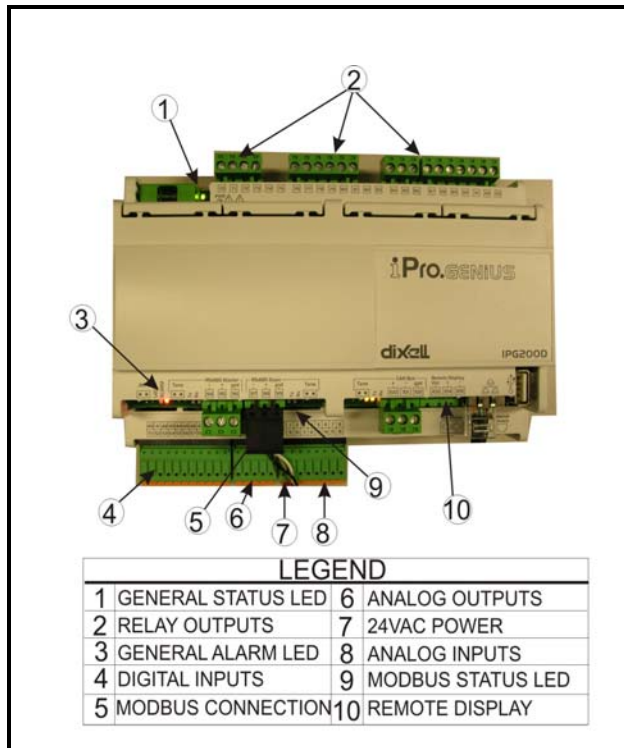

Figure 1-1 - iPro HVAC and Lighting

1.1. The iPro HVAC and Lighting's I/O Points

The iPro HVAC and Lighting supports 15 relay outputs, 6 analog outputs, 10 analog inputs, and 20 digital inputs.

The board has 10 analog inputs and 20 digital inputs. Its 15 relay outputs, rated 2.0 amps max, are used for activating and deactivating fans, heat and cool stages, economizers, and other systems or devices. Its 6 analog outputs may be used for air the damper.

1.2. Independent System Control

The iPro HVAC and Lighting can control 5 lighting zones and 2 rooftop units (up to 2 heat/cool) independently.

2 Mounting and Powering

There are no restrictions on the location of the iPro HVAC and Lighting controller (all local electrical code laws should be followed). The controller should

be mounted in a location/environment that stays within a 20 to 85% relative humidity range (as specified by the label on the enclosure).

2.1. Installation

The iPro HVAC and Lighting uses a DIN mount installation.

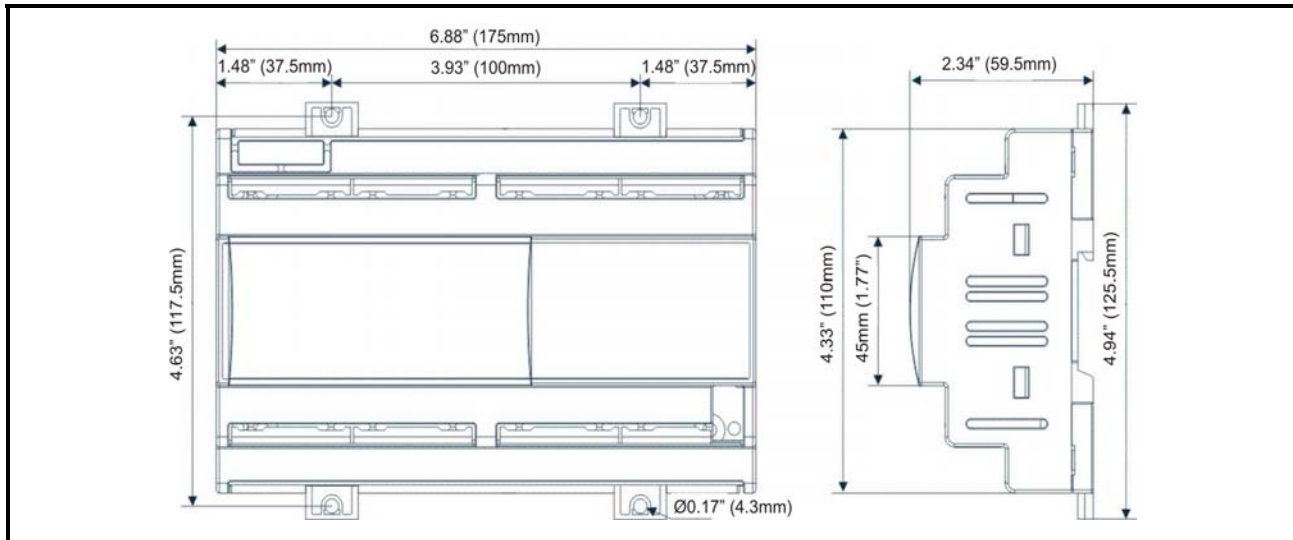

Figure 2-1 - DIN Mounting

2.1.1. Specifications - Mounting and Electrical

Mount:	On a DIN rail (EN 50022, DIN 43880) Fastened with screws via the removable plastic flaps.
Material:	PC-ABS Thermoplastic
Self-extinguishing:	V0 (UL94)
Comparative Tracking Index (CTI):	300V
Color:	White
Power Supply:	24Vac +10/-15%, 50/60Hz 20 - 36Vdc
Consumption:	20VA (Vac), 15W (Vdc)
Connectors:	Phoenix quick coupling connectors for low voltage STELVIO 90° screw connectors for digital outputs (250Vac, 6A max)
Microprocessor:	AT91RM9200 32-bit 200Mhz
Temperature	50°F to 140°F (10 to 60°C)
Relative Humidity (RH)	20 to 85%

Table 2-1 - iPro HVAC and Lighting Specifications

Permanent FLASH Memory:	128Mb, in 8-bit chunks
RAM:	2x128Kb, in 16-bit chunks
Internal Clock:	Standard

Table 2-1 - iPro HVAC and Lighting Specifications

2.2. Powering

Retail Solutions supplies a wide variety of 24VAC transformers with varying sizes without center taps. The power supply can be 24VAC/DC. If 24Vdc is used, **PIN 1 is -** and **PIN 9 is +** (see *Figure 2-2* for PIN 1 and 9 locations). *Table 2-2* shows the transformer sizes and are non-center-tapped.

2.2.1. Choosing Transformer Sizes

The transformer used to power the iPro HVAC and Lighting should have at least a 20VA rating. The iPro HVAC and Lighting should not share a transformer with any other devices.

Transformer P/N	VA Rating	Primary Voltage
640-0041	50 VA	110 VAC
640-0042	50 VA	220 VAC

Table 2-2 - Transformers Compatible with iPro HVAC and Lighting

2.2.2. Power Wiring

iPro HVAC and Lighting units can be powered by one of the 50VA non-center-tapped transformers listed in **Table 2-2**. **Figure 2-2** shows how to wire the transformers to the iPro HVAC and Lighting boards.

Neither side of the secondary should be connected to ground. Also, do not connect the center tap (if provided on the transformer) to ground. The entire secondary of the transformer should be isolated from any ground.

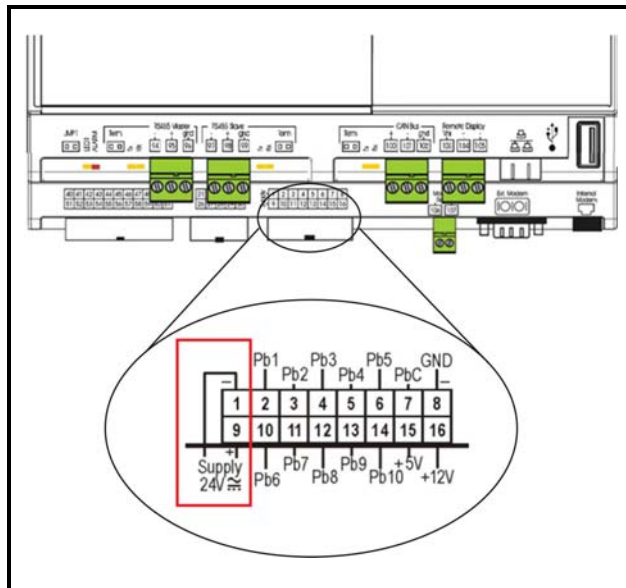

Figure 2-2 - Non-Center-Tapped Transformer Wiring Locations

2.2.3. Wire Types and Maximum Distances

For powering I/O boards, use only the listed wire types in **Table 2-3**. Two-conductor non-shielded cables are the recommended wire for connecting the

transformer to the iPro HVAC and Lighting. Shielded cable should not be used for power wiring. The center tap should be left disconnected, if present on the transformer.

Power Wiring Types	
14 AWG	Belden 9495
18 AWG	Belden 9495

Table 2-3 - Power Wiring Types

The wire length from the transformer determines the type wire gauge used. In most cases, the distance between the iPro HVAC and Lighting and the transformer that supplies power to it is not enough to be of concern; however, it is very important NOT to exceed this maximum wire length or the controller will not operate correctly.

Use these formulas to determine if the wire gauge you are using fits within specification:

14 AWG:
Feet = 1920/VA
18 AWG:
Feet = 739/VA
(VA is the total VA rating of the controller)
For example, if you had an 80 VA load:
14 AWG: 24 ft.
18 AWG: 9 ft. (rounded down)

Table 2-4 - Power Wire Lengths

Sensors requiring 24VAC should not be powered from the same transformer powering the input board. Any devices that will be connected to the iPro HVAC and Lighting unit's inputs or outputs must be powered with a separate 24VAC transformer.

3 Network Addressing - Visograph

The network address makes a board unique from other boards on the network of the same type. This allows the site controller to find it and communicate with it easily.

The network address of the iPro HVAC and Lighting is set using add-on devices called visographs (P/N 318-7272).

3.1. Connecting the Visograph

The visograph is connected with a 3-wire connection on pins 103, 104, and 105.

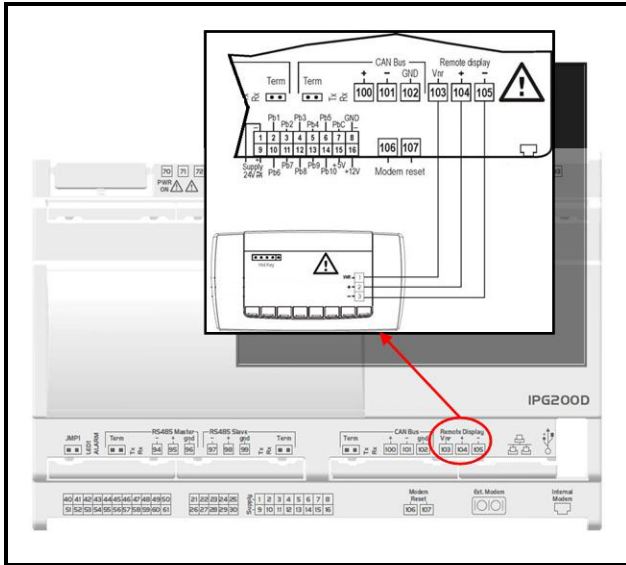

Figure 3-1 - Network ID Settings

CAUTION! The iPro HVAC and Lighting may be damaged if the wires are crossed when connecting the visograph, especially if pin 103 (Vnr) is accidentally connected to + or -

3.2. Visograph Navigation

From the visograph, you can:

- Set MODBUS address
- Configure Lighting
- Configure HVAC

In order to enter the configuration, press keys 1, 3 and 8.

Navigation Buttons in Visograph

- MENU** Press to go back to the main menu.
- ENTER** Selects a field for editing or saves a changed field.
- Left/Right Arrow** Navigate to next or previous field. During edit mode, increases or decreases value.
- Up/Down Arrow** Navigate to next or previous screen.

Figure 3-2 - Visograph Buttons



NOTE: When the MODBUS address is changed, the iPro HVAC and Lighting will automatically reboot.

3.2.1. Versions

If the Visograph version shown is not the most recent, set the **Reload Display** field to **Yes**. This will cause the display to download the latest screens contained in the iPro HVAC and Lighting.

4 Input and Output Setup

The iPro HVAC and Lighting provides separate input commons depending on the type of sensor connected. For temperature probes, all commons should be wired to PbC on terminal 7. For voltage output transducers, all commons should be wired to GND on terminal 8.

4.1. Wiring Analog Inputs

The analog inputs are located on the same connector as the controller power supply.

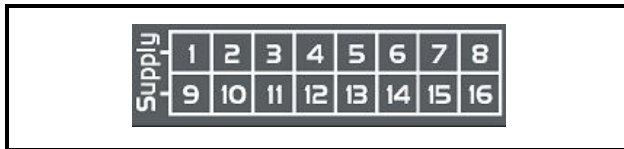

Figure 4-1 - Analog Input Connectors

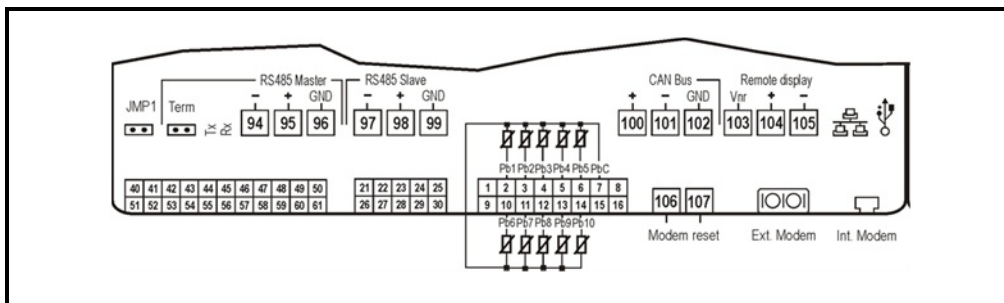

Figure 4-2 - Temperature Probe Wiring

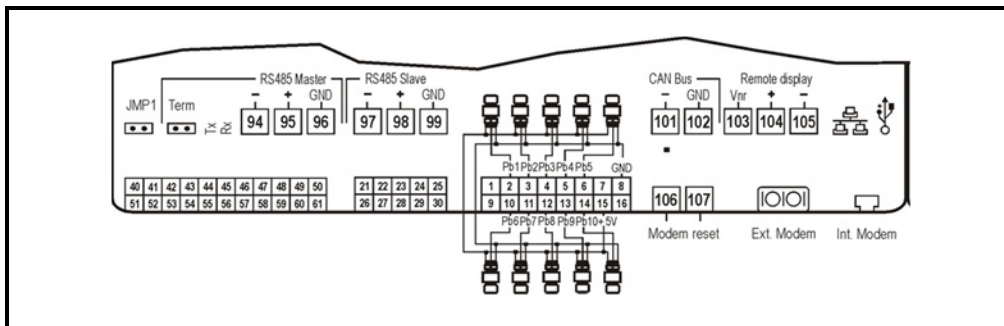

Figure 4-3 - Transducer Wiring for +5V Powered Devices

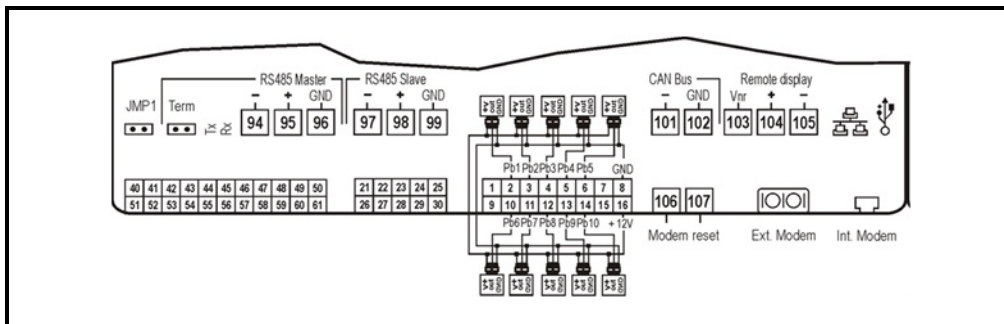

Figure 4-4 - Transducer Wiring for +12V Powered Devices



CAUTION! Mis-wiring a sensor to the wrong common can result in damage to the iPro HVAC and Lighting Controller.



CAUTION! Any inputs that are powered with a voltage that differs from that supplied by the iPro HVAC and Lighting (+12V or +5V) must be powered separately with another transformer in order to prevent the inputs from malfunctioning or being damaged. Do not use the same secondary of the controller's power to power the sensors.

Terminal Number on Connector	Name
1	24VAC Supply -
2	Probe Input 1
3	Probe Input 2
4	Probe Input 3
5	Probe Input 4
6	Probe Input 5
7	Temperature Common
8	GND
9	24VAC Supply +
10	Probe Input 6
11	Probe Input 7
12	Probe Input 8
13	Probe Input 9
14	Probe Input 10
15	+5VDC
16	+12VDC

Table 4-1 - Analog Input Connector Terminal Numbers

4.2. Wiring Digital Inputs

The digital inputs are located on a separate 22-pin connector.



Figure 4-5 - Digital Input Connectors

The iPro HVAC and Lighting provides a maximum of 20 opto-insulated digital inputs. However, only the first ten inputs are currently used (see **Table 4-2**). All digital inputs are voltage-free and are intended to have dry contact devices connected.

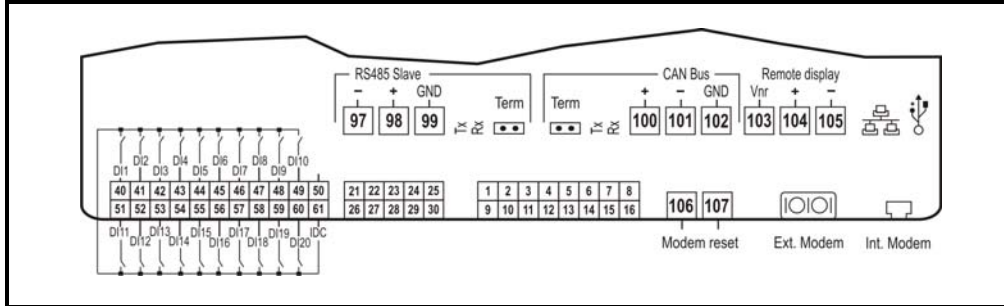

Figure 4-6 - Digital Input Wiring

Terminal Number on Connector	Name
40	Digital Input 1
41	Digital Input 2
42	Digital Input 3
43	Digital Input 4
44	Digital Input 5
45	Digital Input 6
46	Digital Input 7
47	Digital Input 8
48	Digital Input 9
49	Digital Input 10
50	
51	Digital Input 11
52	Digital Input 12
53	Digital Input 13
54	Digital Input 14
55	Digital Input 15
56	Digital Input 16
57	Digital Input 17
58	Digital Input 18
59	Digital Input 19
60	Digital Input 20
61	Volt-free Digital Common

Table 4-2 - Digital Input Connector Terminal Numbers

4.3. Wiring Digital Loads

The digital output relays are located across four separate connectors along the top side of the iPro HVAC and Lighting.

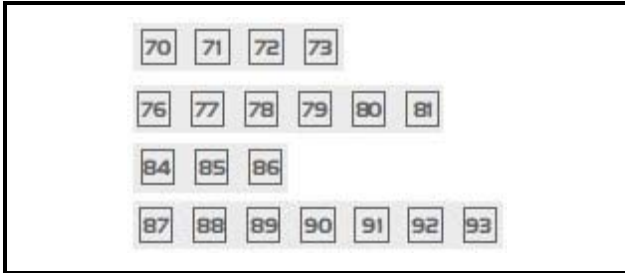

Figure 4-7 - Digital Load Connectors

The normally-open relay outputs on each connector share the same common and are not fused. Make sure to use the same voltage for all loads connected to the relays.

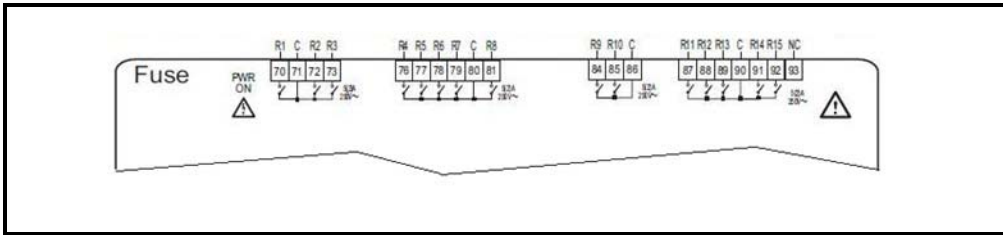

Figure 4-8 - Relay Output Wiring

Terminal Number on Connector	Name
70	Relay 1
71	Common for Relays 1-3
72	Relay 2
73	Relay 3
76	Relay 4
77	Relay 5
78	Relay 6
79	Relay 7
80	Common for Relays 4-8
81	Relay 8
84	Relay 9
85	Relay 10
86	Common for Relays 9-10
87	Relay 11

Table 4-3 -Digital Relay Output Connector Terminal Numbers

88	Relay 12
89	Relay 13
90	Common for Relays 11-15
91	Relay 14
92	Relay 15
93	

Table 4-3 -Digital Relay Output Connector Terminal Numbers

4.4. Wiring Analog Outputs

The analog outputs are located on a separate 12-pin connector.



Figure 4-9 - Analog Outputs Connectors

The iPro HVAC and Lighting provides six opto-isolated analog outputs. Because the analog outputs are opto-isolated, they must be separately powered by a 24V supply. The power supply can be 24VAC/DC. If 24Vdc is used, **PIN 28 is -** and **PIN 29 is +** (see **Figure 4-10** for PIN 28 and 29 locations). For the outputs to function properly, connect a 24VAC supply (separate from the controller's main supply) to terminals 28 and 29. The same transformer used to power the devices controlled by the analog outputs (e.g., damper actuator) may be used to supply power to terminals 28 and 29.

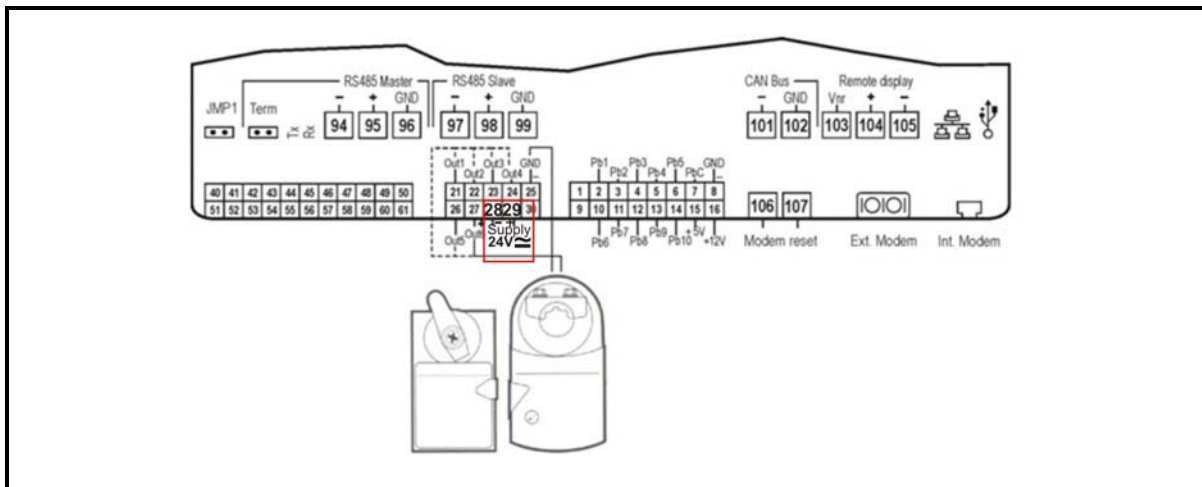

Figure 4-10 - Analog Output Wiring



CAUTION! *The devices controlled by these analog outputs must be powered separately with another transformer (do not use the same secondary of the controller's power) in order to prevent the outputs from malfunctioning or being damaged.*

Terminal Number on Connector	Name
21	Analog Output 1
22	Analog Output 2
23	Analog Output 3
24	Analog Output 4
25	Analog Out Common
26	Analog Output 5
27	Analog Output 6
28	24VAC or 24VDC(-)
29	24VAC or 24VDC(+)
30	Analog Out Common

Table 4-4 -Digital Relay Output Connector Terminal Numbers

5 iPro HVAC and Lighting Status LEDs

When an iPro HVAC and Lighting board is powered up, you will be able to determine the operating status of the board by observing its status LEDs.

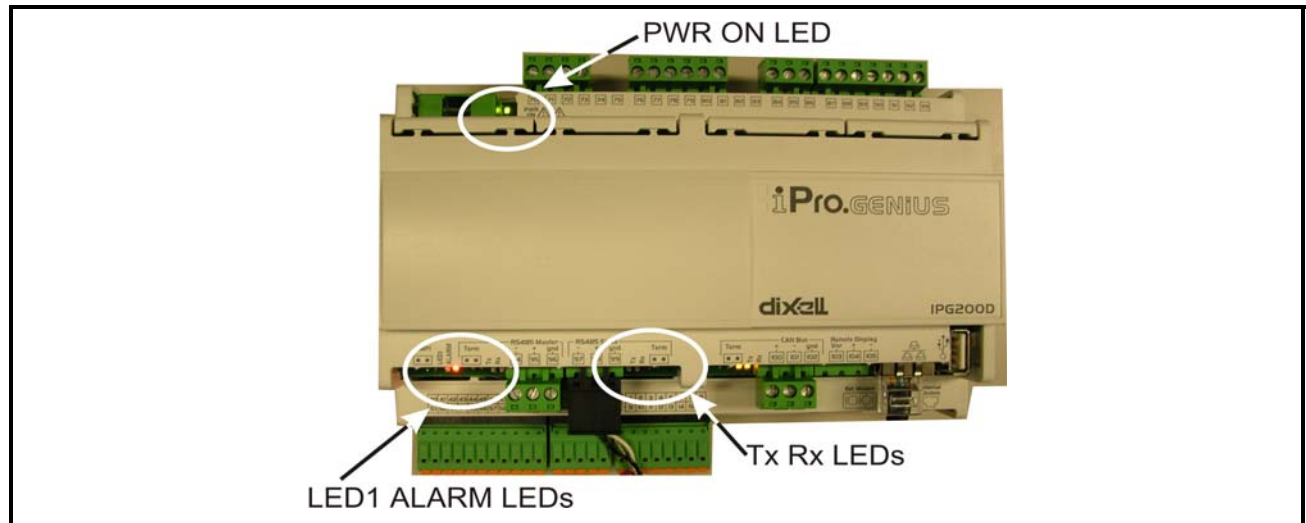

Figure 5-1 -iPro HVAC and Lighting Status LED Locations

PWR ON LED

The PWR ON LED stays on continuously to show that the board is powered and operational. If this light is off, the board has likely lost power.

Tx and Rx LEDs

The Tx and Rx LEDs indicate when the iPro HVAC and Lighting is sending or receiving messages on the RS485 network.

The Tx LED blinks once every time the iPro HVAC and Lighting sends a response to XWEB. The Rx LED blinks once when the iPro HVAC and Lighting receives a message.

If the iPro HVAC and Lighting is connected to the network and set up to communicate with XWEB, you should see these lights blinking regularly. If they do not blink regularly, there may be a problem with the network.

LED1

LED1 is a network status LED.

ALARM LED Status

If the red ALARM LED is on (solid), the iPro HVAC and Lighting has an active alarm. When in this state, the Alarm relay output (if defined) will turn on.

If the red LED is on (solid) if any alarm or error happens; the alarms and errors are as follows:

Alarm:

- 10 probes error
- HVAC1: High temp alarm; Low temp alarm; Differential temp alarm; Fan alarm
- HVAC2: High temp alarm; Low temp alarm; Differential temp alarm; Fan alarm

6 Software Overview

The IPro for HVAC and Lighting and retail stores controls inside, outside lighting and HVAC units. The lighting control has up to 5 zones assigned, (which represents one relay per zone). They drive the lights using schedules, light levels, overrides, and a combination of schedule and light level.

The HVAC control manages up to 2 cool and 2 heating stages plus a fan output (in total 5 outputs per unit). The application runs two units on the main iPro board.

The lighting and HVAC applications are independent of each other. For example, If only lighting control is needed, the controller will operate only the lighting.

All inputs and outputs can be set to any specific function. For example, choose a specific function for DI 1-20, AI 1-10. For analog input AI, space temp can be set for 1-10 as a choice.

Lighting Control Program

Each relay output will have an instance of a lighting control “function block” (5 zones that are either inside or outside applications). All configuration and parameters for the “functions blocks” can be programmed locally (Visograph) and remotely (XWEB).

6.1. Schedules

The application supports 1 Master and 5 Slave schedules. iPro associates a Slave schedule with the Master schedule. All schedules have the ability to be adjusted locally and remotely and support automatic Daylight Savings Time.

6.1.1. Master Schedule Control

The application supports one Master schedule that manages the store hours. All days of the week and three schedule events per day can be user configured (**Table 6-1**). On the Master Schedule, each day of the schedule has 3 different events that can be user defined. Time is in 24-hour format and entered as an absolute time. It also has the ability to associate with all Slave schedules and/or an HVAC unit for Occupied and Unoccupied modes. The Master Schedule defines the OCC mode on all HVAC units depending how it has been configured (Refer to **Section 6.3., HVAC Control**). The resolution is 10 minutes and the events

must be consecutive (it is not possible to “overlap” the events). To disable an event or for unused events, set to 24:00, or set the same value to ON and OFF .

Monday	ON	OFF
Sched Event 1	HH:MM	HH:MM
Sched Event 2	HH:MM	HH:MM
Sched Event 3	HH:MM	HH:MM
Tuesday	ON	OFF
Sched Event 1	HH:MM	HH:MM
Sched Event 2	HH:MM	HH:MM
Sched Event 3	HH:MM	HH:MM

Table 6-1 - Schedule Control

When the master schedule (MS) is configured, these rules must be followed:

The range of MS1 is 0:00 to MS2: *first set the MS2 value*. You will then see that the range of MS1 has changed. Setting the schedule for MS2 first is to prevent the MS1 schedule from occurring after the MS1 schedule (MS2 < MS1) (OFF time >= ON time). The same rule should be applied for MS3, MS4, and MS5 master schedules.

The event should be split between two different days: The first event from 17:00 to 24:00 (for example, Monday) and the second event from 00:00 to 04:00. For example, the day is Tuesday because 00:00 to 04:00 are parameters of the day after Monday. The next example shows that the first event must always be scheduled *before* the last event:

MS1 <= MS2 <= MS3 <= MS4 <= MS5 <= MS6.

MS6 must always be set to a time that occurs *after* an event before it.

The ON time 17:00 and OFF time 4:00 will not be able to be set with XWEB, because when the XWEB writes the data to the iPro HVAC and Lighting controller, the program in the controller will check the data. If the ON time occurs after the OFF time (ON time > OFF time), the data cannot be successfully written to the controller.

The iPro HVAC and Lighting has its own verification program to prevent error data writing.

6.1.2. Slave Schedule Control

The application supports up to 5 Slave schedules, 1 for each lighting relay output, (which represents one relay per zone). Each one needs to have all days of the week available and up to 3 schedule events per day for user configuration. The time will be in 12 hr format entered as a relative time. Meaning, it will be added or subtracted to the schedule event that corresponds to the corresponding day in the Master schedule. The resolution will be 10 minutes. For example, for Sunday: MS1+/-AS1<=MS2+/-AS2<=MS3+/-AS3<=MS4+/-AS4<=MS5+/-AS5<=MS6+/-AS6. The first slave schedule (AS) can be +/- (occur before or after) the time of the first master schedule (MS), but the master and slave schedules that occur before future schedules must be set to a time that occurs before them. For example, MS1+/-AS1 must be set to a time that occurs *before* MS2+/-AS2. Conversely, schedule MS6+/-AS6 cannot occur before MS5+/-AS5.

Monday	ON	OFF
Sched Event 1	-/+ HH:MM	-/+ HH:MM
Sched Event 2	-/+ HH:MM	-/+ HH:MM
Sched Event 3	-/+ HH:MM	-/+ HH:MM
Tuesday	ON	OFF
Sched Event 1	-/+ HH:MM	-/+ HH:MM
Sched Event 2	-/+ HH:MM	-/+ HH:MM
Sched Event 3	-/+ HH:MM	-/+ HH:MM

Table 6-2 - Slave Schedule Control

6.2. Lighting Control

The application will support an inside and outside lighting strategy. Both strategies work with a schedule, either Master or Slave, light level sensor, an override or a combination of a light level and schedule. This delay will be skipped if the DI will be activated except if in Logic Input mode.

In the operating modes using an analog light level value, the value needs to support both Lux and Foot Candle engineering units. The physical input supports a 0-5V light level sensor (Retail Solutions P/N 206-0002). It can also support a 0-10V light level sensor.

6.2.1. Lighting Control - Physical Inputs and Outputs

The maximum number of analog outputs is 6. For lighting we are using only two (at the same time), however all AO should have configurable with AO options in Lighting and HVAC.

The physical inputs available to the lighting control are shown in **Table 6-3**. Digital inputs 1-5 can be assigned to any one of the DI options.

Inputs	Type
Logic/Override for Light 1	DI set between 1-20
Logic/Override for Light 2	DI set between 1-20
Logic/Override for Light 3	DI set between 1-20
Logic/Override for Light 4	DI set between 1-20
Logic/Override for Light 5	DI set between 1-20
Internal Light Level Sensor	Anlg set between 1-10
External Light Level Sensor	Anlg set between 1-10

Table 6-3 - Physical Inputs

The physical outputs available to the lighting control are shown in **Table 6-4**

Outputs	Type
Light 1	RO set between 1-15
Light 2	RO set between 1-15
Light 3	RO set between 1-15
Light 4	RO set between 1-15
Light 5	RO set between 1-15
Dimming Analog Out 1	AO
Dimming Analog Out 2	AO

Table 6-4 - Physical Outputs

6.2.2. Inside Lighting Control

Inside lighting control has four different ways of controlling:

- Dimming Control.
- Schedule Only.
- Schedule and Light Level Combination.
- Logic input.

Parameter	Description	Default	Range
DC1 Maximum Dimming	Maximum Dimming Analog Output	0%-100%	0%-100%
DC2 Minimum Dimming	Minimum Dimming Analog Output	0%-100%	0%-100%
DC3 Max Dim Light Level	Maximum Dimming output at this light level parameter	100 FTC	0-1000 FTC
DC4 Min Dim Light Level	Minimum Dimming output at this light level parameter	500 FTC	0-1000FTC
DC5 Dimming Delay	Time Rate of Change	3 min	0-30 min

Table 6-5 - Dimming Control

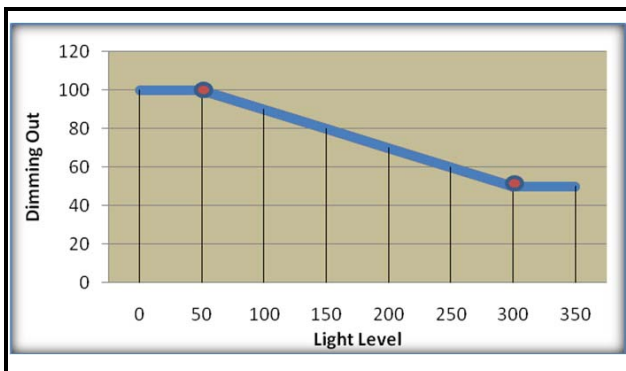

Figure 6-1 - Dimming Levels

The dimming is linear. The end points are a configured set in the user defined parameters (Table 6-5).

6.2.2.1. Dimming Control

In dimming mode, the application works with the internal light level sensor to lower linearly as the light level increases. The mode has four parameters, which are the end points (define the endpoint of the dimming output). The dimming output has a rate of change to the analog output from short cycling.

6.2.2.2. Schedule Only

In Schedule Only mode, the application will only work with the Master or Slave schedule assigned to it. As the schedule changes state, so does the relay output. For example, if the schedule is on, the relay output will also be on.

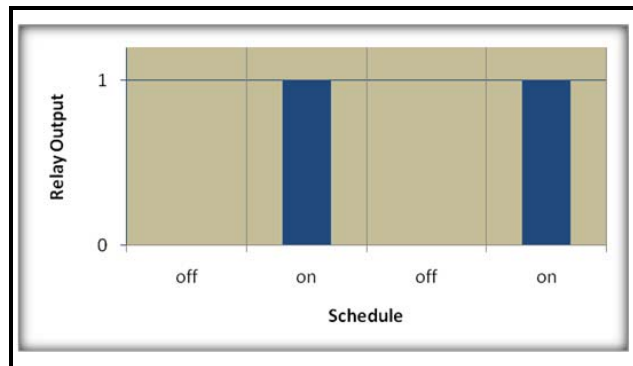

Figure 6-2 - Schedule

6.2.2.3. Schedule and Light Level Combination

With the Schedule and Light Level Combination, the relay output will come on with the schedule and enable the dimming mode, switching it from 0% to the calculated output. Therefore dimming will continue to operate normally as long as the schedule is on.

6.2.2.4. Logic Input

In Logic Input mode, the relay output will come on only if the override input reads an ON signal. Also, if logic input is defined as an override and the inside lights control is in any other mode of operation (Dimming, Schedule-only, Schedule, and Schedule and Dimming combination), the logic input will have priority and turn on the relay output. The application has the ability to switch the polarity of the digital inputs.

6.2.3. Outside Lighting Control

The outside lighting control has four different ways to control:

- Light Level Control.
- Schedule Only.
- Schedule and Light Level Combination.
- Logic input.

6.2.3.1. Light Level Control

In Light Level mode, the application works with the external light level sensor. The mode will have two parameters, cut in and cut out parameters. The relay will turn on when the light level value is below the cut-in parameter and turn off when it is above the cut-out parameter.

Parameter	Description	Range
LLC1 Cut In	Parameter at which the output will be turned ON	0-1000 FTC
LLC2 Cut Out	Parameter at which the output will be turned Off	0-1000FTC

Table 6-6 - Cut Parameter

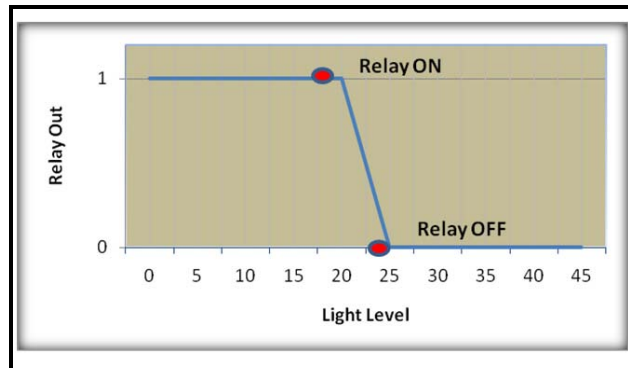

Figure 6-3 - Light Levels

6.2.3.2. Schedule Only

In Schedule Only mode, the application will only work with the Master or Slave schedule assigned to it. As the schedule changes state, so does the relay output. For example, if the schedule is on, the relay output will also be on.

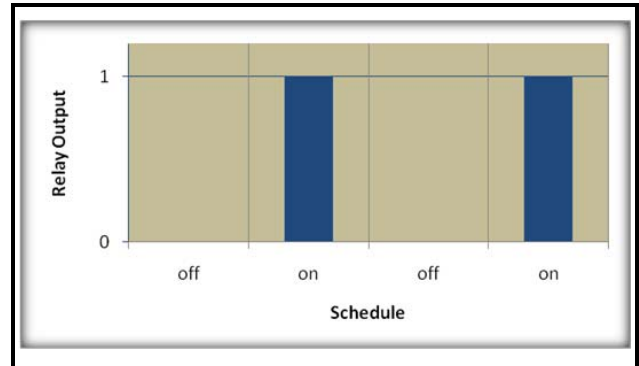

Figure 6-4 - Schedule

6.2.3.3. Schedule and Light Level Combination

In Schedule and Light Level Combination, the relay output will turn on if both the schedule assigned and the light level have triggering their outputs on. In order to turn off the relay output, either the schedule or the light level needs to switch off.

6.2.3.4. Logic Input

In Logic Input mode, the relay output will come on only if the override input reads an ON signal. Additionally, if a logic input is defined as an override and the outside light control is in any other mode of operation (light level, schedule only and schedule and LL combination), the logic input will have priority and turn on the relay output. The application has the ability to switch the polarity of the digital inputs.

6.3. HVAC Control

The application will support up to two HVAC units with up to two stages of cooling and heating. It will also have a fan output for the fan and one economizer output for an economizer. The economizer will modulate to have free cooling and maintain indoor mode. In Indoor Air Quality (IAQ) mode the application works with a CO2 sensor. The application has a heat pump mode option to control in heat pump mode and has a shutdown input. If shutdown input is active,

the unit with the active input will stop its cooling or heating, fan, and economizer control (disables the unit).

The HVAC Control temperature values will support Dixell and CPC sensors in both Fahrenheit and Celsius engineering units.

6.3.1. HVAC Control – Physical Inputs and Outputs-Default Setup

Inputs	Type
RTU 1 Space Temperature 1	Anlg
RTU 1 Space Temperature 2	Anlg
RTU 1 Supply Temperature	Anlg
RTU 1 Return Temperature/Out RH <i>RTU 1 could be configured to Return Temperature/Out RH/CO2</i>	Anlg
RTU 1 Fan Proof	Dig
Emergency Shutdown 1	Dig
RTU 2 Space Temperature 1	Anlg
RTU 2 Space Temperature 2/OAT <i>RTU 2 could be only configured to Space Temperature</i>	Anlg
RTU 2 Supply Temperature	Anlg
RTU 2 Return Temperature/CO2 <i>RTU 2 could be configured to Return Temperature/Out RH/CO2</i>	Anlg
RTU 2 Fan Proof	Dig
Outside Temperature	Anlg

Table 6-7 -HVAC Control Input

Outputs	Type
RTU 1 Fan	RO
RTU 1 Cool1	RO
RTU 1 Cool2	RO
RTU 1 Heat1/Rev Valve	RO
RTU 1 Heat2/Emerg HT	RO
RTU 2 Fan	RO
RTU 2 Cool1	RO
RTU 2 Cool2	RO

Table 6-8 -HVAC Control Output

RTU2 Heat1/Rev Valve	RO
RTU Heat2/Emerg HT	RO
RTU 1 Economizer	AO
RTU 2 Economizer	AO

Table 6-8 -HVAC Control Output

6.3.2. Cooling Control

Cooling control will have the ability to manage up to two stages of cooling using a control temperature.

6.3.2.1. Monitoring and Lockout Temperatures

There will be three monitoring temperatures, Supply, Return, and Outside; however, Return and Outside have alternate roles. The return temperature is the backup control temperature and the Outside is used in the cooling lockout.

Input	Description	Function
Supply Temp	Supply Temperature	Monitoring
Return Temp	Return Temperature	Monitoring/ Control
Outside Temp	Outside Temperature	Monitoring/ LockOut

Table 6-9 - Monitoring and Lockout

LockOut:

Prevents heating from turning on if the outside temperature is above a certain value. Likewise, the cooling should not be allowed to turn on if the outside air is below a certain value.

6.3.2.2. Control Temperature

The application will determine the control temperature from Space Temperature 1 or the average of Space Temperature 1 and 2 if the space temp 2 is defined. If Space Temperature 1 is the only temperature used for controlling and it fails, the backup temperature will be the return temperature. If controlling from the average mode and either of the space temperatures fail, the backup will become the other space tempera-

ture. However, if both temperatures fail in the Average Temperature mode, the backup will then become the return temperature.

Input	Description	Function
Space Temp 1	Space Temperature 1	Control
Space Temp 2	Space Temperature 2	Control

Table 6-10 - Control Temperature

Input	Space Temp 1	Space Temp 2	Return air	Supply air	Backup Response
	Working	NA	Working	Working	Space 1
	Working	Working	Working	Working	Average
Status 1	Fault	Working	Working	Working	Space temp 2
Status 2	Working	Fault	Working	Working	Space Temp 1
Status 3	Fault	NA	Working Fault	Working	Control on return air if Return Probe is configured for RH or CO2. With no Return see Status 6 in this table
Status 4	Fault	Fault	Working Fault	Working	Control on return air if Return Probe is configured for RH or CO2. With no Return see Status 6 in this table
Status 5	Fault	Fault	Fault	Working	Unit stop in alarm
Status 6	Fault	Fault	Fault	Fault	Units stop in alarm

Table 6-11 - Control Temperature

6.3.2.3. Space Temperature Control and Setpoints

The mode of operation will be determined automatically.

The setpoints are divided between occupied and unoccupied; these will be toggled from the Master Schedule in the Lighting Control application.

Occupied mode is generally the time of day a site is open to the public or “occupied;” the time is set in the master schedule. In this mode the HVAC unit will operate with the occupied setpoint.

In unoccupied mode, generally when the site is closed or “unoccupied;” the time is set in the master schedule. In this mode the HVAC unit will operate with the unoccupied setpoint.

Unit 1 Parameters	Unit 2 Parameters	Description	Default	Range
CL1	CL5	Occupied cooling parameter	73 DF	68DF-85DF
CL2	CL6	Cooling Deadband	3 DDF	0DDF-10DDF
CL3	CL7	Unoccupied cooling setpoint	76 DF	68DF-85DF
CL4	CL8	Second Cooling stage Delay	10 minutes	0 min-30 min

Table 6-12 - Occupied Setpoints

6.3.2.4. Cooling Control Strategy

The cooling application will control up to two stages of cooling. If the application is set for one stage, it will turn the cooling relay output on when the control temperature is above the setpoint plus ½ deadband. It will turn off when the control temperature is below setpoint minus ½ deadband.

If the application has been set for two stages of cooling, it will turn on the first cooling stage relay output when the control temperature is above the setpoint plus ½ deadband. Once the first stage of cooling is on and the control temperature is above the setpoint plus ½ for a user defined amount of time (delay), the second stage will turn on. The second stage will turn off once the control temperature is below the setpoint. The first stage will turn off when the control temperature is below setpoint minus ½ deadband.

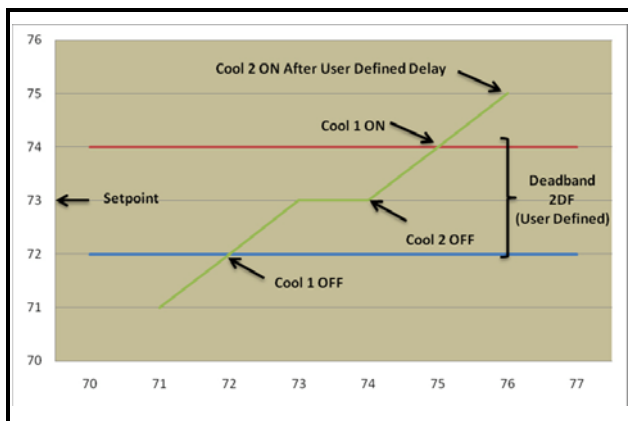

Figure 6-5 - Cooling Control Strategy

6.3.3. Heating Control

Heating control manages a maximum of two stages of heating using the control temperature.

6.3.3.1. Monitoring and Lockout Temperatures

There are three monitoring temperatures, Supply, Return, and Outside; however, Return and Outside will have alternate roles. The return temperature will be the backup control temperature and the Outside will be used in the heating lockout.

The application will use the outside temperature to lock the heating control regulation out.

Input	Description	Function
Supply Temp	Supply Temperature	Monitoring
Return Temp	Return Temperature	Monitoring/ Control
Outside Temp	Outside Temperature	Monitoring/ LockOut

Table 6-13 - Monitoring and Lockout

Monitoring:

Values not used inside the application are available to be read from “outside” (For example: XWEB).

Control:

Value that is used inside the application.

LockOut:

Prevents heating from turning on if the outside temperature is above a certain value. Likewise, the cooling should not be allowed to turn on if the outside air is below a certain value.

6.3.3.2. Control Temperature

The application will determine the control temperature from Space Temperature 1 or the average of Space Temperature 1 and 2. If only controlling of Space Temperature 1 and it fails, the backup temperature will be the return temperature. If controlling from the average mode and either space temperature fails, the backup will be the other space temperature. However, if both temperatures fail in the Average Temperature mode, the backup will be the return temperature. See *Table 6-11*.

Input	Description	Function
Space Temp 1	Space Temperature 1	Control
Space Temp 2	Space Temperature 2	Control

Table 6-14 - Control Temperature

6.3.3.3. Space Temperature Control and Setpoints

The mode of operation will be determined automatically. The setpoints are divided between occupied and unoccupied; these can be toggled from any of the Master Schedules in the Lighting Control application.

Occupied mode is generally the time of day when a store is open. In this mode the HVAC unit will operate with the occupied setpoint.

Unoccupied mode is generally when a store is closed. In this mode the HVAC unit will operate with the unoccupied setpoint.

Unit 1 Parameter	Unit 2 Parameter	Description	Default	Range
HT 1	HT 5	Occupied heating parameter	73 DF	68DF-85DF
HT 2	HT 6	heating Deadband	3 DDF	0DDF-10DDF
HT 3	HT 7	Unoccupied heating setpoint	76 DF	68DF-85DF
HT 4	HT 8	Second heating stage Delay	10 minutes	0 min-30 min

Table 6-15 - Occupied Setpoints

6.3.3.4. Heating Control Strategy

The heating application will control up to two stages of heating. If the application is set for one stage, it will turn on the heating relay output when the control temperature is below the setpoint minus $\frac{1}{2}$ deadband. It will turn off when the control temperature is above setpoint plus $\frac{1}{2}$ deadband.

If the application has been set for two stages of heating, it will turn on the first heating stage relay output when the control temperature is below the setpoint minus $\frac{1}{2}$ deadband. Once the first stage of heating is on and the control temperature is below the setpoint minus $\frac{1}{2}$ for a user defined amount of time (delay), the second stage will turn on. The second stage will turn off once the control temperature is above the setpoint. The first stage will turn off when the control temperature is above setpoint plus $\frac{1}{2}$ deadband.

when the space is in heat mode. The reversing valve operation has a configuration parameter to determine if heating is energize or de-energized. The parameter dictates which way the load pump is active or controls. The user defines whether cooling is energized or de-energized and vice versa. For example, if energized it is in cooling mode, if de-energized it is in heating mode.

The application will turn on cooling stage 1 when first stage of heat pump is on. It will turn on cooling stage 2 when the second stage of heat pump is on.

As for heating stage 2 output, it will act as emergency heat output, which will turn on after the user defined delay and heat pump stage one has been on. If the unit has only one heat pump stage, emergency heat delay will start counting after it.

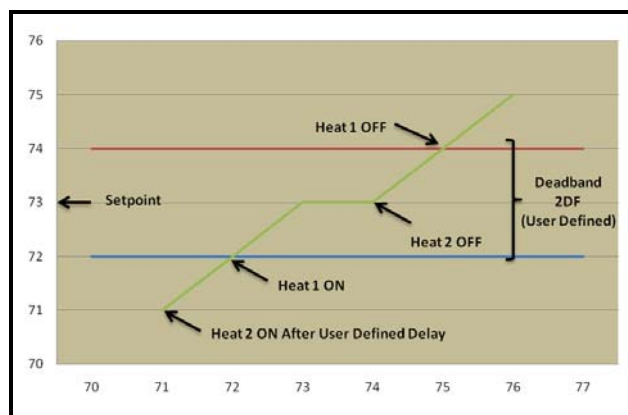

Figure 6-6 - Heating Control Strategy

6.3.3.5. Heat Pump Control

Heat pump control is identical to the heating control; however, the heating stage 1 will act as the reversing valve output. For example, it will be active

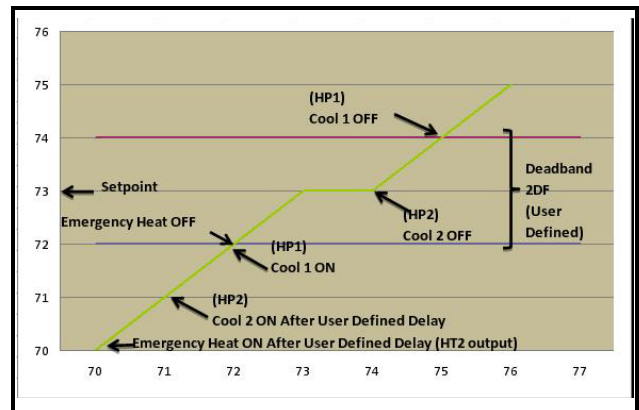

Figure 6-7 - Heat Pump Control

Relay Out (H/C Mode)	Function Becomes →	Heat Pump Mode (HP Mode)
Cool 1	→	HP 1
Cool 2	→	HP 2
HT 1	→	RV
HT 2	→	Emergency HT

Table 6-16 - Functions

The setpoints are divided between occupied and unoccupied; these will be toggled from the Master Schedule in the Lighting Control application.

Occupied mode is generally the time of day a site is open to the public or “occupied;” the time is set in the master schedule. In this mode the HVAC unit will operate with the occupied setpoint.

Unoccupied mode is generally is when the site is closed or “unoccupied;” the time is set in the master schedule. In this mode the HVAC unit will operated with the unoccupied setpoint.

Unit 1 Parameters	Unit 2 Parameters	Description	Default	Range
HT 1	HT 6	Occupied Heating parameter	73 °DF	68°F-85°F
HT 2	HT 7	Heating Deadband	3 °F	0°F-10°F
HT 3	HT 8	Unoccupied Heating setpoint	76 °F	68°F-85°F
HT 4	HT 9	Second Heating stage Delay	10 minutes	0 min-30 min
HT 5	HT 10	Emergency Heating Delay	10 minutes	0 min-30 min

Table 6-17 - Occupied Setpoints

6.3.4. Fan Control

There are two separate Fan Control parameters (HVAC1 and HVAC2).

The fan has the ability to work in either continuous (On) or automatic (Auto) mode. During occupied mode, the fan will be able to run in either mode. However, during unoccupied time the fan will only run in automatic mode.

In Automatic mode, the fan runs any time either cooling or heating is required by the conditioned space. In Continuous mode, the fan operates constantly regardless of cooling or heating. Additionally, the fan has an on and off delay.

Fan control will also have the option to monitor a run input. After a user defined delay, the unit will shut down.

Unit 1 Parameters	Unit 2 Parameters	Description	Default	Range
HF2	HF12	Fan Operating Mode in Summer	Auto	On-Auto
HF3	HF13	Fan Operating Mode in Winter	Auto	On-Auto
HF4	HF14	Fan On Delay	0 minutes	0 min-5 min
HF5	HF15	Fan Off Delay	0 minutes	0 min-5 min
HF6	HF16	Fan Proof Delay	2 minutes	0 min-10 min
HF8	HF18	Summer/Winter setpoint, above setpoint is Summer	55°F	0-90°F
HF9	HF19	Summer/Winter Hysteresis, below set-hys is Winter	5°F	0-90°F

Table 6-18 - Occupied Setpoints

6.3.5. Economizer Control

For Economizer Control there are two separate parameters, for HVAC1 and HVAC 2.

Economizer control will operate the outside damper in Free Cooling mode or by indoor air quality, whichever requires the most.

For Free Cooling in Cooling Mode, the damper observes any lockout to heating and cooling. IAQ will always have priority over lockout and operates normally. Note that Free Cooling is enabled in Cooling Mode, and IAQ is enabled when the CO2 probe is configured.

The outside damper will be only operated by an analog output. Also under the each relay output configuration will be an option to define a relay to drive the economizer when in digital mode (0%=relay off; 100%=relay on).

Free Cooling is enabled only in Cooling Mode and in Heating Mode the damper will only control by the indoor air quality function. The economizer operation in Heating Mode needs to be user defined. Cooling mode comprises Free Cooling and IAQ only. In Heating Mode, IAQ is only available from the damper (no Free Cooling is available in Heating Mode).

6.3.5.1. Economizer Enable

The application will check the valid condition of the outside air by comparing inside and outside temperatures or calculating outside enthalpy and comparing it to an user defined setpoint (see Example 2). If conditions are valid, the application will enable operation of the outside damper by the free cooling mode. If the outside conditions are not optimal, free cooling is disabled.

Enthalpy control calculation is calculated with an outside temperature and humidity. RTU 1 return temp will have the ability to switch to an outside humidity input. Humidity input also needs to support 0-5V, 0-10V, and 4-20MA sensors.

In free cooling, the application will also determine if free cooling is required by the space. It will be determined by offset parameters.

Unit 1 Parameters	Unit 2 Parameters	Description
HE 1	HE 10	Specifies the amount of offset to be subtracted from the active occupied cooling setpoint to determine the space temperature at which economization is needed.
HE 2	HE 11	Specifies the amount of offset to be subtracted from the active unoccupied cooling setpoint to determine the space temperature at which economization is needed.

Table 6-19 - Offset

Once the application has determined the need for the outside damper to open, it will provide a linear output. The active cooling setpoint minus the economizer offset will provide the temperature that the minimum output will be. The active cooling setpoint will be the maximum output.

Unit 2 Parameters	Unit 1 Parameters	Description	Default	Range
HE12	HE 3	Maximum Dimming Analog Output	0%	0%-100%
HE 13	HE 4	Minimum Dimming Analog Output	100%	0%-100%

Table 6-20 - Occupied Setpoints

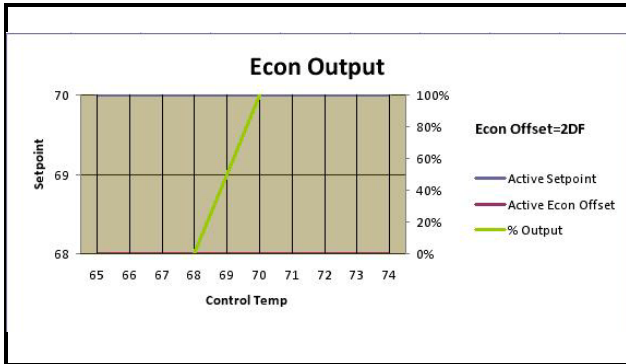

Figure 6-8 - Economization Output

6.3.5.2. Indoor Air Quality

There are two separate IAQ Control for HVAC1 and HVAC2 which are same CO2 sensor.

The Indoor Air Quality Control will share its input with the return temperature on each HVAC unit. If IAQ is required, the use of the return sensor would not be available.

The application will use a CO2 reading and end-point parameters to produce a linear output.

If one of the two Return Probes are configured for CO2, this probe is shared between the two units.

One of the two return probe must be configured as a CO2 sensor. For that Unit this probe wont be used as a back-up probe.

Unit 1 Parameters	Unit 2 Parameters	Description	Default	Range
HI 1	HI 7	Maximum % Analog Output	100%	0%-100%
HI 2	HI 8	Minimum % Analog Output	0%	0%-100%
HI 3	HI 9	Maximum % Output at this CO2 Level	1800	500-3000
HI 4	HI 10	Minimum % Output at this CO2 Level	800	500-3000

Table 6-21 - Input/Output Level

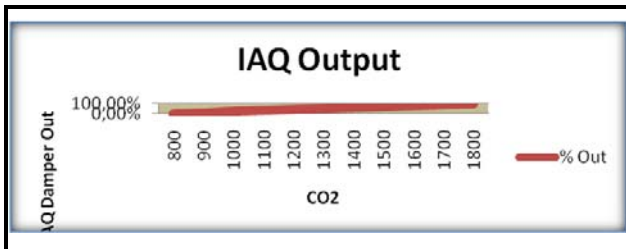

Figure 6-9 - Economization Output

6.3.5.3. Damper Control

The outside damper control will choose the Maximum Analog Output (HI 1) from the IAQ and free cooling modules. It will also have a minimum position available. If the damper is set to a digital mode, the application will trigger a maximum output (100%) when the analog output comparison between IAQ and free cooling reaches 100% and back to its minimum (0%) once it reaches 0%.

6.4. Alarms

The application will have alarm capabilities of high temperature, low temperature, fan proof and supply/return-space differential alarm parameters. All physical input failures will also have alarm capabilities. All alarms have a user-defined delay before the alarm becomes active.

The unit for the Delay of Probe error Alarm has to be entered in seconds, not minutes.

Unit 1 Parameters	Unit 2 Parameters	Alarms	Description	Default	Range
AL1	AL9	HiSpcTemp	High Space Temperature	85DF	70-95 DF
AL2	AL10	HiSpcTemp Dly	High Space Temperature Alarm Delay	60 min	0 min- 180min
AL3	AL11	LoSpcTemp	Lo Space Temperature	60DF	50-70 DF
AL4	AL12	LoSpcTemp Dly	Lo Space Temperature Alarm Delay	60 min	0 min- 180min
AL5	AL13	DiffTempAlrm	Differential Alarm from Return and Supply	16 DDF	0-30 DDF
AL6	AL14	DiffTempAlrm Dly	Differential Alarm Delay	60 min	0 min- 180min
AL7	AL15	FanPrfAlrm	Fan Proof Alarm	NA	NA
AL8	AL16	FanPrfAlrm Dly	Fan Proof Alarm Delay	3 min	0 min- 180min

Table 6-22 - Alarms

6.5. iPro HVAC and Lighting Functions

iPro HVAC and Lighting Functions	Description
Schedules	Supports 1 Master and 5 Slave schedules.
Lighting Control	Support an inside and outside lighting strategy.
HVAC Control	Support up to two HVAC units with up to two stages of cooling, heating, economization and fan Control.
Alarms	alarm capabilities of high temperature, low temperature, fan proof and supply/ return-space differential alarm parameters.

Table 6-23 - Functions

6.6. iPro HVAC and Lighting Parameters

Parameter	Description
Lighting Parameters	
LC3	The unit of the light
MS1	Master Sched Event 1 ON of Sunday
MS2	Master Sched Event 1 OFF of Sunday
MS3	Master Sched Event 2 ON of Sunday
MS4	Master Sched Event 2 OFF of Sunday
MS5	Master Sched Event 3 ON of Sunday
MS6	Master Sched Event 3 OFF of Sunday
MM1	Master Sched Event 1 ON of Monday
MM2	Master Sched Event 1 OFF of Monday
MM3	Master Sched Event 2 ON of Monday
MM4	Master Sched Event 2 OFF of Monday
MM5	Master Sched Event 3 ON of Monday
MM6	Master Sched Event 3 OFF of Monday
MT1	Master Sched Event 1 ON of Tuesday
MT2	Master Sched Event 1 OFF of Tuesday
MT3	Master Sched Event 2 ON of Tuesday
MT4	Master Sched Event 2 OFF of Tuesday
MT5	Master Sched Event 3 ON of Tuesday
MT6	Master Sched Event 3 OFF of Tuesday
MW1	Master Sched Event 1 ON of Wednesday
MW2	Master Sched Event 1 OFF of Wednesday
MW3	Master Sched Event 2 ON of Wednesday

Table 6-24 - iPro HVAC and Lighting Parameters

Parameter	Description
MW4	Master Sched Event 2 OFF of Wednesday
MW5	Master Sched Event 3 ON of Wednesday
MW6	Master Sched Event 3 OFF of Wednesday
TM1	Master Sched Event 1 ON of Thursday
TM2	Master Sched Event 1 OFF of Thursday
TM3	Master Sched Event 2 ON of Thursday
TM4	Master Sched Event 2 OFF of Thursday
TM5	Master Sched Event 3 ON of Thursday
TM6	Master Sched Event 3 OFF of Thursday
MF1	Master Sched Event 1 ON of Friday
MF2	Master Sched Event 1 OFF of Friday
MF3	Master Sched Event 2 ON of Friday
MF4	Master Sched Event 2 OFF of Friday
MF5	Master Sched Event 3 ON of Friday
MF6	Master Sched Event 3 OFF of Friday
SM1	Master Sched Event 1 ON of Saturday
SM2	Master Sched Event 1 OFF of Saturday
SM3	Master Sched Event 2 ON of Saturday
SM4	Master Sched Event 2 OFF of Saturday
SM5	Master Sched Event 3 ON of Saturday
SM6	Master Sched Event 3 OFF of Saturday
AS1	Slave 1 Sched Event 1 ON of Sunday
AS2	Slave 1 Sched Event 1 OFF of Sunday
AS3	Slave 1 Sched Event 2 ON of Sunday
AS4	Slave 1 Sched Event 2 OFF of Sunday
AS5	Slave 1 Sched Event 3 ON of Sunday
AS6	Slave 1 Sched Event 3 OFF of Sunday
AM1	Slave 1 Sched Event 1 ON of Monday
AM2	Slave 1 Sched Event 1 OFF of Monday
AM3	Slave 1 Sched Event 2 ON of Monday
AM4	Slave 1 Sched Event 2 OFF of Monday
AM5	Slave 1 Sched Event 3 ON of Monday
AM6	Slave 1 Sched Event 3 OFF of Monday
AT1	Slave 1 Sched Event 1 ON of Tuesday
AT2	Slave 1 Sched Event 1 OFF of Tuesday
AT3	Slave 1 Sched Event 2 ON of Tuesday
AT4	Slave 1 Sched Event 2 OFF of Tuesday
AT5	Slave 1 Sched Event 3 ON of Tuesday

Table 6-24 - iPro HVAC and Lighting Parameters

Parameter	Description
AT6	Slave 1 Sched Event 3 OFF of Tuesday
AW1	Slave 1 Sched Event 1 ON of Wednesday
AW2	Slave 1 Sched Event 1 OFF of Wednesday
AW3	Slave 1 Sched Event 2 ON of Wednesday
AW4	Slave 1 Sched Event 2 OFF of Wednesday
AW5	Slave 1 Sched Event 3 ON of Wednesday
AW6	Slave 1 Sched Event 3 OFF of Wednesday
TA1	Slave 1 Sched Event 1 ON of Thursday
TA2	Slave 1 Sched Event 1 OFF of Thursday
TA3	Slave 1 Sched Event 2 ON of Thursday
TA4	Slave 1 Sched Event 2 OFF of Thursday
TA5	Slave 1 Sched Event 3 ON of Thursday
TA6	Slave 1 Sched Event 3 OFF of Thursday
AF1	Slave 1 Sched Event 1 ON of Friday
AF2	Slave 1 Sched Event 1 OFF of Friday
AF3	Slave 1 Sched Event 2 ON of Friday
AF4	Slave 1 Sched Event 2 OFF of Friday
AF5	Slave 1 Sched Event 3 ON of Friday
AF6	Slave 1 Sched Event 3 OFF of Friday
SA1	Slave 1 Sched Event 1 ON of Saturday
SA2	Slave 1 Sched Event 1 OFF of Saturday
SA3	Slave 1 Sched Event 2 ON of Saturday
SA4	Slave 1 Sched Event 2 OFF of Saturday
SA5	Slave 1 Sched Event 3 ON of Saturday
SA6	Slave 1 Sched Event 3 OFF of Saturday
BS1	Slave 2 Sched Event 1 ON of Sunday
BS2	Slave 2 Sched Event 1 OFF of Sunday
BS3	Slave 2 Sched Event 2 ON of Sunday
BS4	Slave 2 Sched Event 2 OFF of Sunday
BS5	Slave 2 Sched Event 3 ON of Sunday
BS6	Slave 2 Sched Event 3 OFF of Sunday
BM1	Slave 2 Sched Event 1 ON of Monday
BM2	Slave 2 Sched Event 1 OFF of Monday
BM3	Slave 2 Sched Event 2 ON of Monday
BM4	Slave 2 Sched Event 2 OFF of Monday
BM5	Slave 2 Sched Event 3 ON of Monday
BM6	Slave 2 Sched Event 3 OFF of Monday
BT1	Slave 2 Sched Event 1 ON of Tuesday

Table 6-24 - iPro HVAC and Lighting Parameters

Parameter	Description
BT2	Slave 2 Sched Event 1 OFF of Tuesday
BT3	Slave 2 Sched Event 2 ON of Tuesday
BT4	Slave 2 Sched Event 2 OFF of Tuesday
BT5	Slave 2 Sched Event 3 ON of Tuesday
BT6	Slave 2 Sched Event 3 OFF of Tuesday
BW1	Slave 2 Sched Event 1 ON of Wednesday
BW2	Slave 2 Sched Event 1 OFF of Wednesday
BW3	Slave 2 Sched Event 2 ON of Wednesday
BW4	Slave 2 Sched Event 2 OFF of Wednesday
BW5	Slave 2 Sched Event 3 ON of Wednesday
BW6	Slave 2 Sched Event 3 OFF of Wednesday
TB1	Slave 2 Sched Event 1 ON of Thursday
TB2	Slave 2 Sched Event 1 OFF of Thursday
TB3	Slave 2 Sched Event 2 ON of Thursday
TB4	Slave 2 Sched Event 2 OFF of Thursday
TB5	Slave 2 Sched Event 3 ON of Thursday
TB6	Slave 2 Sched Event 3 OFF of Thursday
BF1	Slave 2 Sched Event 1 ON of Friday
BF2	Slave 2 Sched Event 1 OFF of Friday
BF3	Slave 2 Sched Event 2 ON of Friday
BF4	Slave 2 Sched Event 2 OFF of Friday
BF5	Slave 2 Sched Event 3 ON of Friday
BF6	Slave 2 Sched Event 3 OFF of Friday
SB1	Slave 2 Sched Event 1 ON of Saturday
SB2	Slave 2 Sched Event 1 OFF of Saturday
SB3	Slave 2 Sched Event 2 ON of Saturday
SB4	Slave 2 Sched Event 2 OFF of Saturday
SB5	Slave 2 Sched Event 3 ON of Saturday
SB6	Slave 2 Sched Event 3 OFF of Saturday
CS1	Slave 3 Sched Event 1 ON of Sunday
CS2	Slave 3 Sched Event 1 OFF of Sunday
CS3	Slave 3 Sched Event 2 ON of Sunday
CS4	Slave 3 Sched Event 2 OFF of Sunday
CS5	Slave 3 Sched Event 3 ON of Sunday
CS6	Slave 3 Sched Event 3 OFF of Sunday
CM1	Slave 3 Sched Event 1 ON of Monday
CM2	Slave 3 Sched Event 1 OFF of Monday
CM3	Slave 3 Sched Event 2 ON of Monday

Table 6-24 - iPro HVAC and Lighting Parameters

Parameter	Description
CM4	Slave 3 Sched Event 2 OFF of Monday
CM5	Slave 3 Sched Event 3 ON of Monday
CM6	Slave 3 Sched Event 3 OFF of Monday
CT1	Slave 3 Sched Event 1 ON of Tuesday
CT2	Slave 3 Sched Event 1 OFF of Tuesday
CT3	Slave 3 Sched Event 2 ON of Tuesday
CT4	Slave 3 Sched Event 2 OFF of Tuesday
CT5	Slave 3 Sched Event 3 ON of Tuesday
CT6	Slave 3 Sched Event 3 OFF of Tuesday
CW1	Slave 3 Sched Event 1 ON of Wednesday
CW2	Slave 3 Sched Event 1 OFF of Wednesday
CW3	Slave 3 Sched Event 2 ON of Wednesday
CW4	Slave 3 Sched Event 2 OFF of Wednesday
CW5	Slave 3 Sched Event 3 ON of Wednesday
CW6	Slave 3 Sched Event 3 OFF of Wednesday
TC1	Slave 3 Sched Event 1 ON of Thursday
TC2	Slave 3 Sched Event 1 OFF of Thursday
TC3	Slave 3 Sched Event 2 ON of Thursday
TC4	Slave 3 Sched Event 2 OFF of Thursday
TC5	Slave 3 Sched Event 3 ON of Thursday
TC6	Slave 3 Sched Event 3 OFF of Thursday
CF1	Slave 3 Sched Event 1 ON of Friday
CF2	Slave 3 Sched Event 1 OFF of Friday
CF3	Slave 3 Sched Event 2 ON of Friday
CF4	Slave 3 Sched Event 2 OFF of Friday
CF5	Slave 3 Sched Event 3 ON of Friday
CF6	Slave 3 Sched Event 3 OFF of Friday
SC1	Slave 3 Sched Event 1 ON of Saturday
SC2	Slave 3 Sched Event 1 OFF of Saturday
SC3	Slave 3 Sched Event 2 ON of Saturday
SC4	Slave 3 Sched Event 2 OFF of Saturday
SC5	Slave 3 Sched Event 3 ON of Saturday
SC6	Slave 3 Sched Event 3 OFF of Saturday
DS1	Slave 4 Sched Event 1 ON of Sunday
DS2	Slave 4 Sched Event 1 OFF of Sunday
DS3	Slave 4 Sched Event 2 ON of Sunday
DS4	Slave 4 Sched Event 2 OFF of Sunday
DS5	Slave 4 Sched Event 3 ON of Sunday

Table 6-24 - iPro HVAC and Lighting Parameters

Parameter	Description
DS6	Slave 4 Sched Event 3 OFF of Sunday
DM1	Slave 4 Sched Event 1 ON of Monday
DM2	Slave 4 Sched Event 1 OFF of Monday
DM3	Slave 4 Sched Event 2 ON of Monday
DM4	Slave 4 Sched Event 2 OFF of Monday
DM5	Slave 4 Sched Event 3 ON of Monday
DM6	Slave 4 Sched Event 3 OFF of Monday
DT1	Slave 4 Sched Event 1 ON of Tuesday
DT2	Slave 4 Sched Event 1 OFF of Tuesday
DT3	Slave 4 Sched Event 2 ON of Tuesday
DT4	Slave 4 Sched Event 2 OFF of Tuesday
DT5	Slave 4 Sched Event 3 ON of Tuesday
DT6	Slave 4 Sched Event 3 OFF of Tuesday
DW1	Slave 4 Sched Event 1 ON of Wednesday
DW2	Slave 4 Sched Event 1 OFF of Wednesday
DW3	Slave 4 Sched Event 2 ON of Wednesday
DW4	Slave 4 Sched Event 2 OFF of Wednesday
DW5	Slave 4 Sched Event 3 ON of Wednesday
DW6	Slave 4 Sched Event 3 OFF of Wednesday
TD1	Slave 4 Sched Event 1 ON of Thursday
TD2	Slave 4 Sched Event 1 OFF of Thursday
TD3	Slave 4 Sched Event 2 ON of Thursday
TD4	Slave 4 Sched Event 2 OFF of Thursday
TD5	Slave 4 Sched Event 3 ON of Thursday
TD6	Slave 4 Sched Event 3 OFF of Thursday
DF1	Slave 4 Sched Event 1 ON of Friday
DF2	Slave 4 Sched Event 1 OFF of Friday
DF3	Slave 4 Sched Event 2 ON of Friday
DF4	Slave 4 Sched Event 2 OFF of Friday
DF5	Slave 4 Sched Event 3 ON of Friday
DF6	Slave 4 Sched Event 3 OFF of Friday
SD1	Slave 4 Sched Event 1 ON of Saturday
SD2	Slave 4 Sched Event 1 OFF of Saturday
SD3	Slave 4 Sched Event 2 ON of Saturday
SD4	Slave 4 Sched Event 2 OFF of Saturday
SD5	Slave 4 Sched Event 3 ON of Saturday
SD6	Slave 4 Sched Event 3 OFF of Saturday
ES1	Slave 5 Sched Event 1 ON of Sunday

Table 6-24 - iPro HVAC and Lighting Parameters

Parameter	Description
ES2	Slave 5 Sched Event 1 OFF of Sunday
ES3	Slave 5 Sched Event 2 ON of Sunday
ES4	Slave 5 Sched Event 2 OFF of Sunday
ES5	Slave 5 Sched Event 3 ON of Sunday
ES6	Slave 5 Sched Event 3 OFF of Sunday
EM1	Slave 5 Sched Event 1 ON of Monday
EM2	Slave 5 Sched Event 1 OFF of Monday
EM3	Slave 5 Sched Event 2 ON of Monday
EM4	Slave 5 Sched Event 2 OFF of Monday
EM5	Slave 5 Sched Event 3 ON of Monday
EM6	Slave 5 Sched Event 3 OFF of Monday
ET1	Slave 5 Sched Event 1 ON of Tuesday
ET2	Slave 5 Sched Event 1 OFF of Tuesday
ET3	Slave 5 Sched Event 2 ON of Tuesday
ET4	Slave 5 Sched Event 2 OFF of Tuesday
ET5	Slave 5 Sched Event 3 ON of Tuesday
ET6	Slave 5 Sched Event 3 OFF of Tuesday
EW1	Slave 5 Sched Event 1 ON of Wednesday
EW2	Slave 5 Sched Event 1 OFF of Wednesday
EW3	Slave 5 Sched Event 2 ON of Wednesday
EW4	Slave 5 Sched Event 2 OFF of Wednesday
EW5	Slave 5 Sched Event 3 ON of Wednesday
EW6	Slave 5 Sched Event 3 OFF of Wednesday
TE1	Slave 5 Sched Event 1 ON of Thursday
TE2	Slave 5 Sched Event 1 OFF of Thursday
TE3	Slave 5 Sched Event 2 ON of Thursday
TE4	Slave 5 Sched Event 2 OFF of Thursday
TE5	Slave 5 Sched Event 3 ON of Thursday
TE6	Slave 5 Sched Event 3 OFF of Thursday
EF1	Slave 5 Sched Event 1 ON of Friday
EF2	Slave 5 Sched Event 1 OFF of Friday
EF3	Slave 5 Sched Event 2 ON of Friday
EF4	Slave 5 Sched Event 2 OFF of Friday
EF5	Slave 5 Sched Event 3 ON of Friday
EF6	Slave 5 Sched Event 3 OFF of Friday
SE1	Slave 5 Sched Event 1 ON of Saturday
SE2	Slave 5 Sched Event 1 OFF of Saturday
SE3	Slave 5 Sched Event 2 ON of Saturday

Table 6-24 - iPro HVAC and Lighting Parameters

Parameter	Description
SE4	Slave 5 Sched Event 2 OFF of Saturday
SE5	Slave 5 Sched Event 3 ON of Saturday
SE6	Slave 5 Sched Event 3 OFF of Saturday
SEb1	Slave 1
SEb2	Slave 2
SEb3	Slave 3
SEb4	Slave 4
SEb5	Slave 5
IO1	Inside or Outside of light1
IO2	Inside or Outside of light2
IO3	Inside or Outside of light3
IO4	Inside or Outside of light4
IO5	Inside or Outside of light5
LR1	The relay is used for the light 1
LR2	The relay is used for the light 2
LR3	The relay is used for the light 3
LR4	The relay is used for the light 4
LR5	The relay is used for the light 5
LAO1	The analog output is used for the light 1
LAO2	The analog output is used for the light 2
LAO3	The analog output is used for the light 3
LAO4	The analog output is used for the light 4
LAO5	The analog output is used for the light 5
LDI1	The override digital input is used for the light 1
LDI2	The override digital input is used for the light 2
LDI3	The override digital input is used for the light 3
LDI4	The override digital input is used for the light 4
LDI5	The override digital input is used for the light 5
LAI1	The analog input is used for the inside light level sensor
LAI2	The analog input is used for the outside light level sensor
DC1	Maximum Dimming Analog Output
DC2	Minimum Dimming Analog Output
DC3	Minimum light level
DC4	Maximum light level
DC5	Delay before Dimming output makes a change
LLC1	Parameter at which the output will be turned ON
LLC2	Parameter at which the output will be turned Off
DoN1	Relay ON delay for Light 1

Table 6-24 - iPro HVAC and Lighting Parameters

Parameter	Description
DoN2	Relay ON delay for Light 2
DoN3	Relay ON delay for Light 3
DoN4	Relay ON delay for Light 4
DoN5	Relay ON delay for Light 5
DoF1	Relay OFF delay for Light 1
DoF2	Relay OFF delay for Light 2
DoF3	Relay OFF delay for Light 3
DoF4	Relay OFF delay for Light 4
DoF5	Relay OFF delay for Light 5
AiC	The inside control mode of Light 1
BiC	The inside control mode of Light 2
CiC	The inside control mode of Light 3
DiC	The inside control mode of Light 4
EiC	The inside control mode of Light 5
AoC	The outside control mode of Light 1
BoC	The outside control mode of Light 2
CoC	The outside control mode of Light 3
DoC	The outside control mode of Light 4
EoC	The outside control mode of Light 5
EL1	Enable Light 1
EL2	Enable Light 2
EL3	Enable Light 3
EL4	Enable Light 4
EL5	Enable Light 5
SnT1	Inside Light Level Sensor Type
SnT2	Outside Light Level Sensor Type
HVAC Regulation Parameters	
HC1	Enable HVAC
HC2	The digital input is used to shut down the HVAC
HC3	The measure unit of HVAC
HC4	Sensor type
HP1	Supply Temperature of unit 1 choosing Probe
HP2	Return Temperature of unit 1 choosing Probe
HP3	Outside Temperature of HVAC choosing Probe
HP4	Space 1 Temperature of unit 1 choosing Probe
HP5	Space 2 Temperature of unit 1 choosing Probe
HP6	Space 2 Temperature of unit 1 Presence
HP7	Supply Temperature of unit 2 choosing Probe

Table 6-24 - iPro HVAC and Lighting Parameters

Parameter	Description
HP8	Return Temperature of unit 2 choosing Probe
HP10	Space 1 Temperature of unit 2 choosing Probe
HP11	Space 2 Temperature of unit 2 choosing Probe
HP12	Space 2 Temperature of unit 2 Presence
CL1	Occupied cooling setpoint of unit 1
CL2	Cooling Deadband of unit 1
CL3	Unoccupied cooling setpoint of unit 1
CL4	Second Cooling stage Delay of unit 1
CL5	Occupied cooling setpoint of unit 2
CL6	Cooling Deadband of unit 2
CL7	Unoccupied cooling setpoint of unit 2
CL8	Second Cooling stage Delay of unit 2
Ht1	Occupied Heating setpoint of unit 1
Ht2	Heating Deadband of unit 1
Ht3	Unoccupied Heating setpoint of unit 1
Ht4	Second Heating stage Delay of unit 1
Ht5	Heat pump mode Emergency Heating Delay of unit 1
Ht6	Occupied Heating setpoint of unit 2
Ht7	Heating Deadband of unit 2
Ht8	Unoccupied Heating setpoint of unit 2
Ht9	Second Heating stage Delay of unit 2
Ht10	Heat pump mode Emergency Heating Delay of unit 2
CLS1	Cooling stage 2 Enable for unit 1
CLS2	Cooling stage 2 Enable for unit 2
HtS1	Heating stage 2 Enable for unit 1
HtS2	Heating stage 2 Enable for unit 2
LK1	Cooling LockOut Setpoint for Unit 1
LK2	Cooling LockOut Setpoint for Unit 2
LK3	Heating LockOut Setpoint for Unit 1
LK4	Heating LockOut Setpoint for Unit 2
CR1	Digital Output of Cooling Stage 1 for Unit 1
CR2	Digital Output of Cooling Stage 2 for Unit 1
HR1	Digital Output of Heating Stage 1 for Unit 1
HR2	Digital Output of Heating Stage 2 for Unit 1
CR3	Digital Output of Cooling Stage 1 for Unit 2
CR4	Digital Output of Cooling Stage 2 for Unit 2
HR3	Digital Output of Heating Stage 1 for Unit 2
HR4	Digital Output of Heating Stage 2 for Unit 2

Table 6-24 - iPro HVAC and Lighting Parameters

Parameter	Description
TR1	Cooling TR(Throttle Range) for Unit 1
TR2	Cooling TR(Throttle Range) for Unit 2
TR3	Heating TR(Throttle Range) for Unit 1
TR4	Heating TR(Throttle Range) for Unit 2
Pm1	Heat Pump Mode for Unit 1
Pm2	Reversing Valve status in Cooling Mode for Unit 1
Pm3	Delay of Valve switch before Cooling/ Heating Work for Unit 1
Pm4	Delay of Valve switch after Cooling/ Heating Stop for Unit 1
Pm5	Heat Pump Mode for Unit 2
Pm6	Reversing Valve status in Cooling Mode for Unit 2
Pm7	Delay of Valve switch before Cooling/ Heating Work for Unit 2
Pm8	Delay of Valve switch after Cooling/ Heating Stop for Unit 2
HVAC Fan Parameters	
HF1	The digital input match the fan status of unit 1
HF2	Fan Operating Mode of unit 1 in Summer
HF3	Fan Operating Mode of unit 1 in Winter
HF4	Fan On Delay of unit 1
HF5	Fan Off Delay of unit 1
HF6	Fan Proof Delay of unit 1
HF7	Digital Output of Fan for Unit 1
HF8	Summer/Winter setpoint, above setpoint is Summer for HVAC
HF9	Summer/Winter Hysteresis, below set-hys is Winter for HVAC
HF10	Enable/Disable the Shut down for Unit 1
HF11	The digital input match the fan status of unit 2
HF12	Fan Operating Mode of unit 2 in Summer
HF13	Fan Operating Mode of unit 2 in Winter
HF14	Fan On Delay of unit 2
HF15	Fan Off Delay of unit 2
HF16	Fan Proof Delay of unit 2
HF17	Digital Output of Fan for Unit 2
HF20	Enable/Disable the Shut down for Unit 2
HF21	after Fan 1 recovery, during this time if DI status not match again, Unit 1 shutdown forever
HF22	after Fan 2 recovery, during this time if DI status not match again, Unit 2 shutdown forever
HF23	Unit 1 restart delay when DI status recover
HF24	Unit 2 restart delay when DI status recover
HVAC Economizer Parameters	
HE1	Economizer Offset Occupied of unit 1

Table 6-24 - iPro HVAC and Lighting Parameters

Parameter	Description
HE2	Economizer Offset Unoccupied of unit 1
HE3	Maximum Analog Output for Free Cooling of unit 1
HE4	Minimum Analog Output for Free Cooling of unit 1
HE5	The analog output is use for damper of unit 1
HE6	The Relay is use for the damper of unit 1
HE7	Economizer Output mode of unit 1
HE8	Comparing Temperature or Comparing enthalpy for Unit 1 Free Cooling Enable
HE9	the setpoint that comparing with outside enthalpy for Unit1
HE10	Economizer Offset Occupied of unit 2
HE11	Economizer Offset Unoccupied of unit 2
HE12	Maximum Analog Output for Free Cooling of unit 2
HE13	Minimum Analog Output for Free Cooling of unit 2
HE14	The analog output is use for damper of unit 2
HE15	The Relay is use for the damper of unit 2
HE16	Economizer Output mode of unit 2
HE17	Comparing Temperature or Comparing enthalpy for Unit 2 Free Cooling Enable
HE18	the setpoint that comparing with outside enthalpy for Unit2
HI1	Maximum Analog Output for IAQ of unit 1
HI2	Minimum Analog Output for IAQ of unit 1
HI3	Maximum Analog Output at this CO2 Level of unit 1
HI4	Miimumum Analog Output at this CO2 Level of unit 1
HI5	RTU1 PROBE CO2 lower limit for unit 1
HI6	RTU1 PROBE CO2 upper limit for unit 1
HI7	Maximum Analog Output for IAQ of unit 2
HI8	Minimum Analog Output for IAQ of unit 2
HI9	Maximum Analog Output at this CO2 Level of unit 2
HI10	Miimumum Analog Output at this CO2 Level of unit 2
HI11	RTU2 PROBE CO2 lower limit for unit 2
HI12	RTU2 PROBE CO2 upper limit for unit 2
EC1	RTU1 Probe Input for unit 1
EC2	RTU1 Probe Type for unit 1
EC3	RTU2 Probe Input for unit 2
EC4	RTU2 Probe Type for unit 2
Other Parameters	
AL1	High Space Temperature of unit 1
AL2	High Space Temperature Alarm Delay of unit 1
AL3	Lo Space Temperature of unit 1

Table 6-24 - iPro HVAC and Lighting Parameters

Parameter	Description
AL4	Lo Space Temperature Alarm Delay of unit 1
AL5	Differential Alarm from Return and Supply of unit 1
AL6	Differential Alarm Delay of unit 1
AL7	Fan Proof Alarm of unit 1
AL8	Fan Proof Alarm Delay of unit 1
AL9	High Space Temperature of unit 2
AL10	High Space Temperature Alarm Delay of unit 2
AL11	Lo Space Temperature of unit 2
AL12	Lo Space Temperature Alarm Delay of unit 2
AL13	Differential Alarm from Return and Supply of unit 2
AL14	Differential Alarm Delay of unit 2
AL15	Fan Proof Alarm of unit 2
AL16	Fan Proof Alarm Delay of unit 2
RLP1	Polarity of RL1
RLP2	Polarity of RL2
RLP3	Polarity of RL3
RLP4	Polarity of RL4
RLP5	Polarity of RL5
RLP6	Polarity of RL6
RLP7	Polarity of RL7
RLP8	Polarity of RL8
RLP9	Polarity of RL9
RLP10	Polarity of RL10
RLP11	Polarity of RL11
RLP12	Polarity of RL12
RLP13	Polarity of RL13
RLP14	Polarity of RL14
RLP15	Polarity of RL15
DIP1	Polarity of DI01
DIP2	Polarity of DI02
DIP3	Polarity of DI03
DIP4	Polarity of DI04
DIP5	Polarity of DI05
DIP6	Polarity of DI06
DIP7	Polarity of DI07
DIP8	Polarity of DI08
DIP9	Polarity of DI09
DIP10	Polarity of DI10

Table 6-24 - iPro HVAC and Lighting Parameters

Parameter	Description
DIP11	Polarity of DI11
DIP12	Polarity of DI12
DIP13	Polarity of DI13
DIP14	Polarity of DI14
DIP15	Polarity of DI15
DIP16	Polarity of DI16
DIP17	Polarity of DI17
DIP18	Polarity of DI18
DIP19	Polarity of DI19
DIP20	Polarity of DI20
OFs1	Probe 1 Offset
OFs2	Probe 2 Offset
OFs3	Probe 3 Offset
OFs4	Probe 4 Offset
OFs5	Probe 5 Offset
OFs6	Probe 6 Offset
OFs7	Probe 7 Offset
OFs8	Probe 8 Offset
OFs9	Probe 9 Offset
OFs10	Probe 10 Offset
DpA	Delay of Probe error Alarm

Table 6-24 - iPro HVAC and Lighting Parameters

Input	Description	Output	Description
PB1	Internal Light Level Sensor	R1	Lighting Relay 1
PB2	External Light Level Sensor	R2	Lighting Relay 2
PB3	RTU 1 Space Temperature 1	R3	Lighting Relay 3
PB4	RTU 1 Space Temperature 2	R4	RTU 1 Fan
PB5	RTU 1 Supply Temperature	R5	RTU 1 Cool1
PB6	RTU 1 Return Temperature/Out RH	R6	RTU 1 Cool2
PB7	RTU 2 Space Temperature 1	R7	RTU 1 Heat1/Rev Valve
PB8	RTU 2 Space Temperature 2	R8	RTU 1 Heat2/Emerg HT
PB9	RTU 2 Supply Temperature	R9	Lighting Realy 4
PB10	RTU 2 Return Temperature/CO2	R10	Lighting Relay 5
DI1	Logic/Override for Relay 1	R11	RTU 2 Fan
DI2	Logic/Override for Relay 2	R12	RTU 2 Cool1
DI3	Logic/Override for Relay 3	R13	RTU 2 Cool2

Table 6-25 - IPRO Retail Controller I/O (5 Lighting Outputs & 2 RTU)

DI4	Logic/Override for Relay 4	R14	RTU2 Heat1/Rev Valve
DI5	Logic/Override for Relay 5	R15	RTU Heat2/Emerg HT
DI6	RTU 1 Fan Proof	AO1	Dimming Analog Out
DI7	Emergency Shutdown 1	AO2	Outside Damper 1
DI8	RTU 2 Fan Proof	AO3	Outside Damper 2
DI9	Emergency Shutdown 2	AO4	NA
DI10	NA	AO5	NA
DI11	NA	AO6	NA
DI12	NA		
DI13	NA		
DI14	NA		
DI15	NA		
DI16	NA		
DI17	NA		
DI18	NA		
DI19	NA		
DI20	NA		

Table 6-25 - iPRO Retail Controller I/O (5 Lighting Outputs & 2 RTU)

7 Connections

7.1. iPro HVAC and Lighting Connector Descriptions











Connector	Function
	Connector for 24VAC/DC power supply analog inputs (Pb1 - Pb10, PbC) Additional power (+5VDC, +12VDC, GND)
	Opto-insulated analog outputs (Out1 - Out6, GND) 24VAC/DC power supply for the opto-insulated analog output
	Potential free opto-insulated digital inputs (DI1 - DI20, DIC) Opto-insulated 24VAC/DC digital inputs (DI1 - DI20, GND)
	USB port for downloads (BIOS, ISA-GRAF® application, maps of parameters, remote display applications, network configuration, website) and uploads (log files)
	TCP/IP Ethernet port
	Connector for remote terminal (VISO-GRAPH), maximum 2 terminals per iPro HVAC and Lighting.
	CANBUS connector for expansions (IPEXx0D) and drivers for electronic valves (XEVx0D) Rx and Tx LED to indicate that communication is active Closed circuit terminal (Term)
	RS485 Slave connector Rx and Tx LED to indicate that communication is active Closed circuit terminal (Term)
	RS485 Master connector Rx and Tx LED to indicate that communication is active Closed circuit terminal (Term)
	Digital relay outputs (for digital outputs with potential free contacts) 3 NO relays, 1 common

Table 7-1 - Descriptions of the Connections





Connector	Function
	Digital relay outputs (for digital outputs with live contacts) 3 NO relays, 1 common and 2 potential free (Neutral)
	Digital relay outputs (for digital outputs with potential free contacts) 5 NO relays, 1 common
	Digital relay outputs (for digital outputs with live contacts) 5 NO relays, 1 common and 2 potential free (Neutral)
	Digital relay outputs 2 NO relays, 1 common
	Digital relay outputs (only for 215D versions) 5 NO relays, 1 common and 1 potential free (Neutral)

Table 7-1 - Descriptions of the Connections

7.2. Terminal Number Descriptions

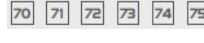
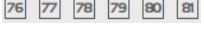
Terminal No.	Type of Input	Description
1	Supply	Power 24VAC or 24VDC(-)
2	Pb1	Analog Input 1 (Temperature, 0-10V, 0-1V, 0-5V)
3	Pb2	Analog Input 2 (Temperature, 0-10V, 0-1V, 0-5V)
4	Pb3	Analog Input 3 (Temperature, 0-10V, 0-1V, 0-5V)
5	Pb4	Analog Input 4 (Temperature, 0-10V, 0-1V, 0-5V)
6	Pb5	Analog Input 5 (Temperature, 0-10V, 0-1V, 0-5V)
7	PbC	Common for temperature inputs (<i><u>DO NOT TIE TO GROUND</u></i>)
8	GND(-)	Additional power reference 5Vdc and 12Vdc and analog inputs (0 -10V, 0 -1V, 0 -5V)
9	Supply	Power 24Vac or 24Vdc(+)
10	Pb6	Analog Input 6 (Temperature, 0-10V, 0-1V, 0-5V)
11	Pb7	Analog Input 7 (Temperature, 0-10V, 0-1V, 0-5V)
12	Pb8	Analog Input 8 (Temperature, 0-10V, 0-1V, 0-5V)
13	Pb9	Analog Input 9 (Temperature, 0-10V, 0-1V, 0-5V)
14	Pb10	Analog Input 10 (Temperature, 0-10V, 0-1V, 0-5V)
15	+5V	Additional power +5Vdc
16	+12V	Additional power +12Vdc
21	Out1	Opto-insulated analog output 1, 0 -10V
22	Out2	Opto-insulated analog output 2, 0 -10V
23	Out3	Opto-insulated analog output 3, 0 -10V
24	Out4	Opto-insulated analog output 4, 0 -10V
25	GND(-)	Common opto-insulated analog output
26	Out5	analog output 5, 0 -10V
27	Out6	analog output 6, 0 -10V
28	Supply	Power for opto-insulated analog outputs at 24VAC or 24VDC(-)
29	Supply	Power for opto-insulated analog outputs at 24VAC or 24VDC(+)
30	GND(-)	Common opto-insulated analog output
40	DI1	Opto-insulated digital input 1
41	DI2	Opto-insulated digital input 2
42	DI3	Opto-insulated digital input 3
43	DI4	Opto-insulated digital input 4
44	DI5	Opto-insulated digital input 5
45	DI6	Opto-insulated digital input 6
46	DI7	Opto-insulated digital input 7

Table 7-2 - Terminal Number Descriptions

47	DI8	Opto-insulated digital input 8
48	DI9	Opto-insulated digital input 9
49	DI10	Opto-insulated digital input 10
50	GND(-)	Common opto-insulated digital inputs 1 to 20 (if inputs 24Vac or 24Vdc)
51	DI11	Opto-insulated digital input 11
52	DI12	Opto-insulated digital input 12
53	DI13	Opto-insulated digital input 13
54	DI14	Opto-insulated digital input 14
55	DI15	Opto-insulated digital input 15
56	DI16	Opto-insulated digital input 16
57	DI17	Opto-insulated digital input 17
58	DI18	Opto-insulated digital input 18
59	DI19	Opto-insulated digital input 19
60	DI20	Opto-insulated digital input 20
61	IDC	Common opto-insulated digital inputs 1 to 20 (if potential free inputs)
70	RL1	Relay 1 normally open contact
71	C	Common relays 1, 2 and 3
72	RL2	Relay 2 normally open contact
73	RL3	Relay 3 normally open contact
74	C	Not Used
75	C	Not Used
76	RL4	Relay 4 normally open contact
77	RL5	Relay 5 normally closed contact
78	RL6	Relay 6 normally closed contact
79	RL7	Relay 7 normally closed contact
80	C	Common relays 4, 5, 6, 7 and 8
81	RL8	Relay 8 normally closed contact
82	C	Not Used
83	C	Not Used
84	RL9	Relay 9 normally closed contact
85	RL10	Relay 10 normally closed contact
86	C	Common relays 9 and 10
87	RL11	Relay 11 normally closed contact
88	RL12	Relay 12 normally closed contact
89	RL13	Relay 13 normally closed contact
90	C	Common relays 11, 12, 13, 14 and 15
91	RL14	Relay 14 normally closed contact
92	RL15	Relay 15 normally closed contact
93	C	Not Used

Table 7-2 - Terminal Number Descriptions

94	RS485 Master	RS485 Master connection (-)
95	RS485 Master	RS485 Master connection (+)
96	RS485 Master	RS485 Master connection (insulated gnd)
97	RS485 Slave	RS485 Slave connection (-)
98	RS485 Slave	RS485 Slave connection (+)
99	RS485 Slave	RS485 Slave connection (insulated gnd)
100	CAN Bus	CAN Bus connection (+), not open
101	CAN Bus	CAN Bus connection (-), not open
102	CAN Bus	CAN Bus connection (insulated gnd), not open
103	Remote Display	Connection for VISOGRAPH remote terminal (Vnr)
104	Remote Display	Connection for VISOGRAPH remote terminal (+)
105	Remote Display	Connection for VISOGRAPH remote terminal (-)
106	Modem Reset	Not Used
107	Modem Reset	Not Used

Table 7-2 - Terminal Number Descriptions

7.3. Technical Specifications

7.3.1. Analog Inputs

Analog conversion type:	10-bit A/D converter
Number of inputs:	10
Type of analog input: (configurable via software parameter)	NTC Dixell (-50T110°C; 10KΩ±1% at 25°C) PTC Dixell(-55T115°C; 990Ω±1% at 25°C) Digital input (potential free contact) Voltage: 0 - V, 0 - 5V, 0 - 10V (input resistance 3.7KΩ) Current: 0 - 20mA, 4 - 20mA (input resistance 100Ω)
Digital input status variation detection time:	100ms (in any case it depends on the cycle time set by the user in the given application)
Accuracy:	NTC, PTC: ±1? 0-1V: ±20mV 0-5V: ±100mV 0-10V:±200mV 2-20mA, 4-20mA: ±0.30mA
Additional power:	+12V: 200mA in total +5v: 100mA

Table 7-3 - Analog Input Specifications



CAUTION! Any inputs that are powered with a voltage that differs from that supplied by the device (+12V or +5V) must be powered separately with another transformer (do not use the same secondary of the controller's power) in order to prevent the inputs from malfunctioning or being damaged.

7.3.2. Digital Inputs

Type: (configurable via software parameter)	Opto-insulated potential free or live contact (24VAC/DC) External power 24Vac/dc ±20%
Number of inputs:	20
Digital input status variation detection time:	100ms (in any case it depends on the cycle time set by the user in the given application)

Table 7-4 - Digital Input Specifications



CAUTION! If the digital inputs are used with voltage, use another transformer (do not use the same secondary of the controller's power) in order to prevent the inputs from malfunctioning or being damaged.

7.3.3. Analog Outputs

Type:	Opto-insulated with separate 24VAC/DC power supply
Number of outputs:	10
Type of analog output: (configurable via software parameter)	4 fixed outputs 0-10VDC (Out1 - Out4) 2 configurable outputs 0-10VDC, 4-20mA (Out5 and Out6)
Maximum load:	40mA (Out1 - Out4) 20mA (Out5 and Out6) max with configured outputs 0-10VDC 400Ω max with configured outputs 4-20Ma 22Ω per live analog output
Accuracy:	Out1 - Out4: ±2% full scale Out5 - Out6: ±2% full scale
Resolution:	8bit

Table 7-5 - Analog Outputs Specification



CAUTION! *The electrical devices controlled by these analog outputs must be powered separately with another transformer (do not use the same secondary of the controller's power) in order to prevent the outputs from malfunctioning or being damaged.*

7.3.4. Digital Outputs

Type:	Relays with NO contacts
Number of outputs:	10 or 15, depending on the model
Type of output: (configurable via software parameter)	Relays with normally open contact
Maximum load:	5A(250Vac) SPST 5(2)A

Table 7-6 - Digital Outputs Specifications



CAUTION! *Verify the capacity of the output used. There is double insulation between the digital outputs and the low voltage of the rest of the circuit. Do not use different voltages for the various groups of relays nor within each group.*

7.4. Wiring

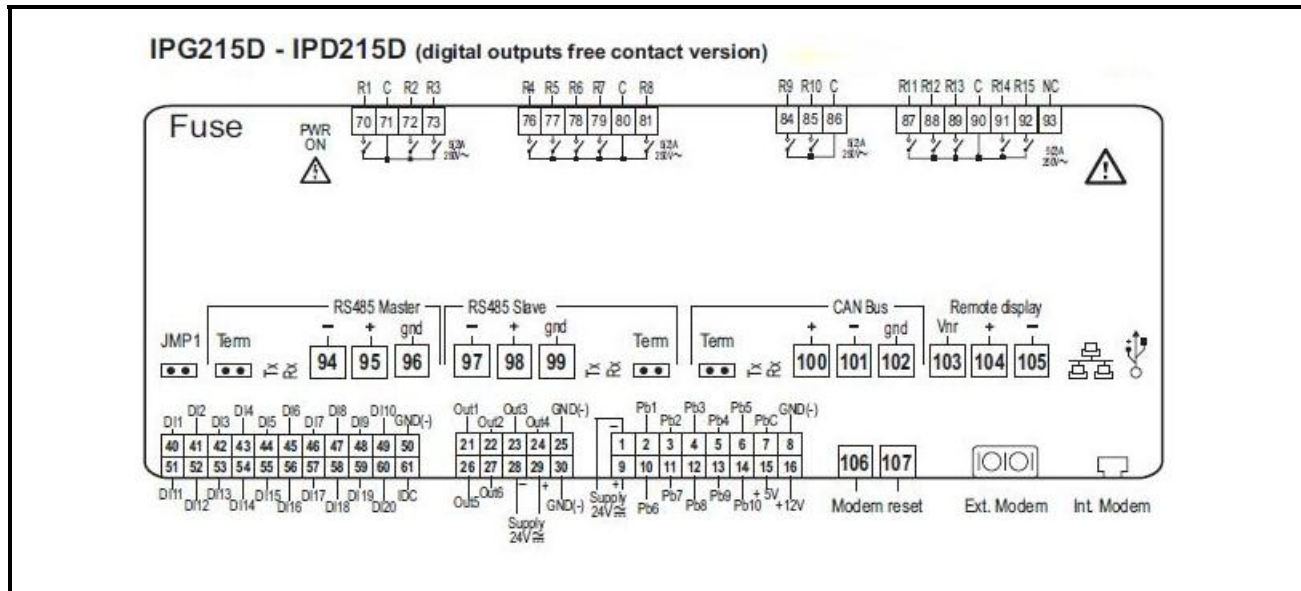

Figure 7-1 - iPro HVAC and Lighting Detail

Index

-A-

Addressing iPro DAC 4
AWG 3

-C-

Connections 39
Connector Functions 39

-D-

Damper Control 22
Digital Inputs 6
Digital Loads 8
DIN Mounting 2
Distance of Wiring 3

-F-

Fan Control 20

-H-

HVAC Control 15
 Cooling 16
 Heat Pump 19
 Heating 18

-I-

I/O Points 1
Independent Control 1
Indoor Air Quality 22
Input Specs 42
Installation 2

-L-

LEDs 11
Lighting Control 13
 Dimming Control 14
 Inside Control 14
 Outside Lighting 15
 Physical Inputs and Outputs 13
 Schedule 14

-M-

MODBUS
 Wiring 3
Mounting and Powering 2

-O-

Output Specs 43

-P-

Powering 2

-S-

Schedules 12
 Master Schedule 12
 Slave Schedule 13
Software Overview 12
Specifications 42
 analog inputs 42
 analog outputs 43
 digital inputs 42

-T-

Terminal Number Descriptions 40
Transformers and Ratings 3

-V-

Visograph
 Buttons 4
 Connectivity 4
Visograph Connectivity 4

-W-

Warnings
 Analog Inputs 6
 Analog Outputs 9
 Output Capacity 43
 Transformers 43
 Voltages 43
 Wire Length 3
Wire Distance 3
Wire Gauge/Types 3
Wiring 44

The contents of this publication are presented for informational purposes only and they are not to be construed as warranties or guarantees, express or implied, regarding the products or services described herein or their use or applicability. Computer Process Controls, Inc. reserves the right to modify the designs or specifications of such products at any time without notice. Computer Process Controls, Inc. does not assume responsibility for the selection, use or maintenance of any product. Responsibility for proper selection, use and maintenance of any Computer Process Controls, Inc. product remains solely with the purchaser and end-user.

026-1728 25-AUG-2011 Emerson is a trademark of Emerson Electric Co. ©2011 Computer Process Controls, Inc. All rights reserved. Printed in the USA.