

Copeland Scroll™

ZX Condensing Unit for Refrigeration Applications



User Manual

Copeland Scroll™

EMERSON™
Climate Technologies

Pioneering Technologies For Best-In-Class Products

Emerson Climate Technologies, a business segment of Emerson, is the world's leading provider of heating, air conditioning and refrigeration solutions for residential, industrial and commercial applications. The group combines best-in-class technology with proven engineering, design, distribution, educational and monitoring services to provide customized, integrated climate-control solutions for customers worldwide. Emerson Climate Technologies' innovative solutions, which include industry-leading brands such as Copeland Scroll and White-Rodgers, improve human comfort, safeguard food and protect the environment. For more information, visit EmersonClimateAsia.com.

Our Vision:

Emerson Climate Technologies, With Our Partners,
Will Provide Global Solutions To Improve Human Comfort,
Safeguard Food And Protect The Environment.

Emerson Climate Technologies is pleased to offer the ZX platform refrigeration condensing units (CDU) specifically designed for medium temperature (ZX-MT & ZXB-MT), digital modulated variable capacity medium temperature (ZXD) and low temperature (ZXL-LT) refrigeration.

ZX series CDU has been highly successful in the Asian market and enjoys proven success with its energy savings and customer-friendly electronic features.



Table of Contents

Disclaimer	04
Features and Benefits	04
Nomenclature	05
Bill of Material	05
Physical Layout of the Unit	06
Product Specification	
Qualified Refrigerants And Oils	07
CoreSense™ for ZX Platform Condensing Unit	07
Network Wiring	12
Installation	
Condensing Unit Handling	14
Electrical Connection	15
Refrigeration Piping Installation	16
ZXL Liquid Line Insulation	16
Brazing Recommendations	16
Expansion Valve Selection for Low Ambient Application	17
Location and Fixing	17
Start Up and Operation	18
Controller Initialization Message	18
Alarm Codes	20
Wiring Diagrams	23
Contact Lists	32

ZX Platform CDU

Disclaimer

Thank you for purchasing the ZX platform condensing unit from Emerson Climate Technologies. ZX platform CDUs are the best in class within the capacity and operating range available in the market. ZX CDU is designed to operate reliably and to deliver high operating efficiencies in medium and low temperature refrigeration applications. It also provides constant monitoring of the compressor operating conditions and displays the running or fault conditions of the CDU. ZX platform CDUs have to be installed by following the industry trade practices for its safe and reliable operation. It is assumed that the CDU

is selected, installed and serviced only by professionals. The user manual does not cover good industry practices which are essential on a refrigeration equipment installation. No responsibility can be accepted for damage caused by inexperienced or inadequately trained site technicians or improper installation design.

If in doubt, please consult your local sales office, quoting unit model and serial number as shown on each unit nameplate. In case of any ambiguity, the wiring diagram supplied with each unit takes precedence over the diagram in this manual.

Introduction to ZX Platform CDU

ZX medium temperature, ZXB medium temperature, ZXD digital medium temperature and ZXL low temperature series have been highly successful in the Asian market and enjoys proven success with its energy savings and customer-friendly electronic features. ZX, ZXB, ZXD and ZXL CDUs have been applied by several well-known end-users and chain retailers throughout Asia. The ZX platform is also gaining wider acceptance in the global market and specific variants have been developed and exported to the USA and to the European and Middle East markets.

Receiving your unit

All units are shipped with a holding charge of dry nitrogen inside at a low but positive pressure. Suitable labeling is prominently displayed on both the unit and the packaging. Service connectors are provided on the CDU service valve for the convenient checking of the integrity of the holding charge.

Caution! It is very important to check that this holding pressure exists at the time you receive each unit from us or our authorized representatives. Please inform us or our authorized representative if the holding charge is non-existent. Failure to do so could void the claim for other related system faults at a later period.

Transit damage is essentially an insurance claim and is not covered under manufacturing defect. It is also advisable to inspect the rest of the unit for obvious physical damage and inform us or our authorized representative in case any is discovered.

ZX Platform Condensing Unit was designed based on three factors demanded by industry users:

Intelligent Store Solutions - A most innovative approach to enterprise facility management, Emerson's Intelligent Store™ architecture integrates hardware and services, to provide retailers a single view into their entire network of facilities and understanding what facilities actually cost to operate and maintain.

The Intelligent Store architecture transforms data from store equipment and controls into actionable insights. Designed to deliver value in both new and existing stores, Emerson aims to help the retailers:

- Make better decisions on recourses investment for greatest impact
- Gain accurate feedback and customized service to your specific needs
- Reduce operational costs and boost the profitability at most convenience

Energy Efficiency - Utilizing Copeland Scroll™ compressor technology, variable speed fan motor, large capacity condenser coil and advanced control algorithms, energy consumption is significantly reduced. End-users can save more than 20% on annual energy costs rather than using hermetic reciprocating units.

Reliability - Combining the proven reliability of Copeland Scroll compressors with advanced electronics controller and diagnostics, equipment reliability is greatly enhanced. Fault code alerts and fault code retrieval capabilities provide information to help improve speed and accuracy of system diagnostics. Integrated electronics provide protection against over-current, over-heating, incorrect phase rotation, compressor cycling, high pressure resets, low pressure cut-outs. It can also send out a warning message to an operator when there is a liquid floodback, which can prevent critical damage on the unit.

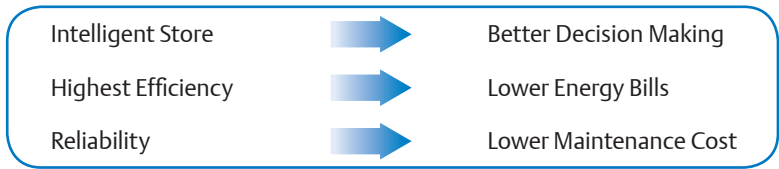

Variable Speed Fan Motor and High Efficiency Fan Blade

Optimized Condenser Coil for Maximum Heat Transfer

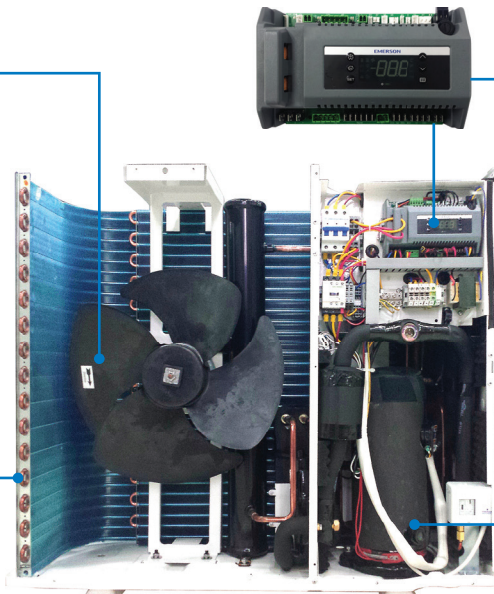

ZX, ZXB and ZXL Family

Proprietary electronic algorithms present advantage on diagnose, communication, and protection purposes. They are also fundamental to control fan speed, optimizing Energy Performance for Local Seasonal Ambient Temperatures

ZXD Family

Capacity modulation to control precise room temperature and humidity

Design Features:

- With real time monitoring of compressor operating conditions
- Compressor Reverse Rotation
- Compressor Over Current
- Compressor Internal Motor Protector Trip
- Discharge Gas Over Heat
- Over Voltage
- Under Voltage
- High Pressure Cut Out
- Low Pressure Cut Out (only on MT series)
- Refrigerant Flood Back
- Compressor Minimum Off Time
- Internal Thermal Sensor Failure
- Intelligent Store Solution: Communication and Retail Store Monitoring

Copeland Scroll Compressor Technology - High Efficiency, Ultra Quiet, High Reliability

Figure 1. ZX Platform CDU Features

Nomenclature

ZX	L	020	B	E	-	TFD	451
Unit Family	Blank = Medium Temp B = R134a Medium Temp L = Low Temp D = Digital Medium Temp	2.0 to 7.6 HP	Generation	E = Ester Oil O = Mineral Oil		PFJ = 220V/240V - 1ph - 50 Hz TFD = 380V/420V - 3ph - 50 Hz TF5=200V/230V - 3ph - 60 Hz TF7 = 380 - 3ph - 60 Hz	Bill of Material
Base Model						Electrical Code	Bill of Material

Bill of Material

CDU Family	ZX			ZXB			ZXL				ZXD	
BOM	401	451	481	401	451	461	451	461	471	481	451	461
Liquid Line Filter Dryer	✓	✓	✓	✓	✓	✓	✓	✓	✓	✓	✓	✓
Sight Glass	✓	✓	✓	✓	✓	✓	✓	✓	✓	✓	✓	✓
Oil Separator		✓	✓		✓	✓	✓	✓	✓	✓	✓	✓
Accumulator							✓	✓	✓	✓		
Adjustable LP Switch	✓	✓	✓	✓	✓	✓	✓	✓	✓	✓		✓
Fixed HP Switch	✓	✓	✓	✓	✓	✓	✓	✓	✓	✓	✓	✓
Fixed LP Switch	✓	✓									✓	✓
CoreSense™	✓	✓	✓	✓	✓	✓	✓	✓	✓	✓	✓	✓
Intelligent Store Solution Module	✓	✓	✓	✓	✓	✓	✓	✓	✓	✓	✓	✓
Fan Speed Controller	✓	✓	✓	✓	✓	✓	✓	✓	✓	✓	✓	✓
Circuit Breaker	✓	✓	✓	✓	✓	✓	✓	✓	✓	✓	✓	✓
Sound Jacket	✓	✓	✓	✓	✓	✓	✓	✓	✓	✓	✓	✓
Low Ambient Kit			✓							✓		
Filter Drier									ACC			

Note: ACC-Accessory
BOM:
4xx - Chassis with door
5xx - Chassis without door

Physical Layout of the Unit

The following figures give an introduction to the physical layout of the ZX Platform CDU

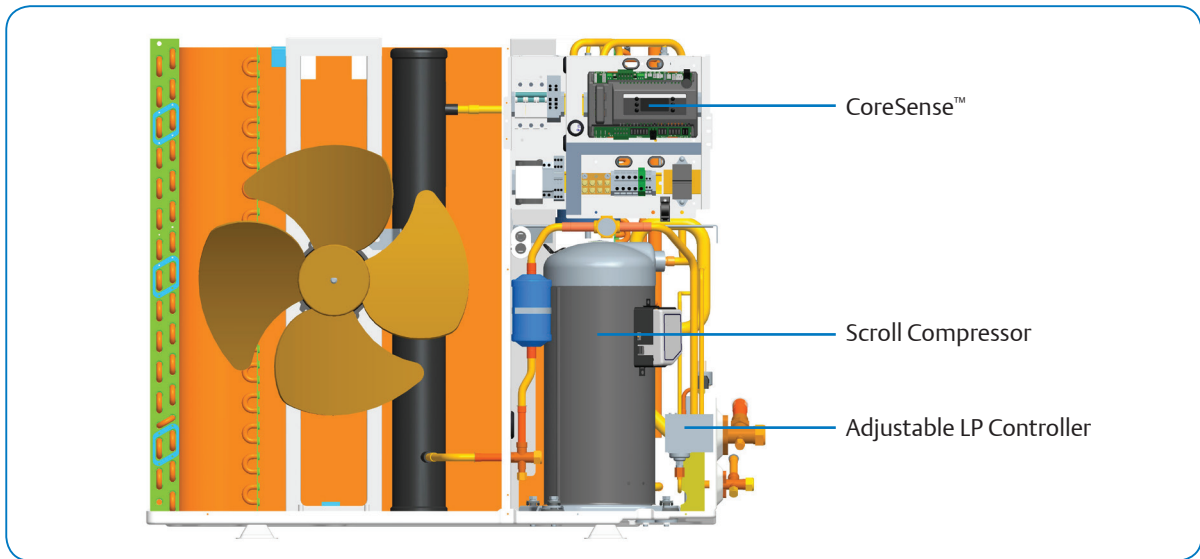

Figure 2. CoreSense™ and other components in ZX Platform CDU

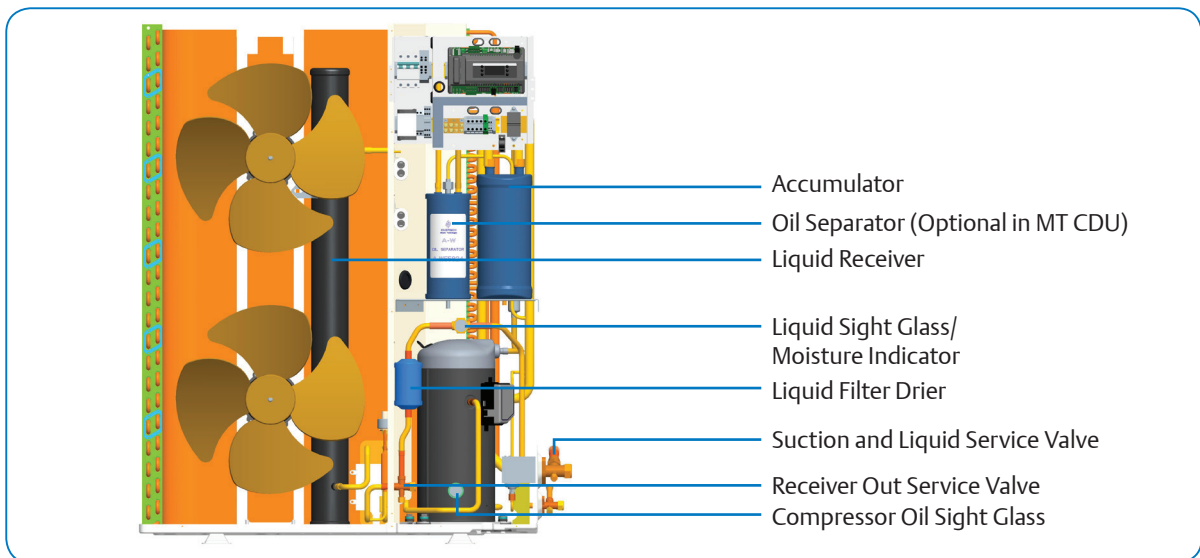

Figure 3. Major components of ZX Platform CDU

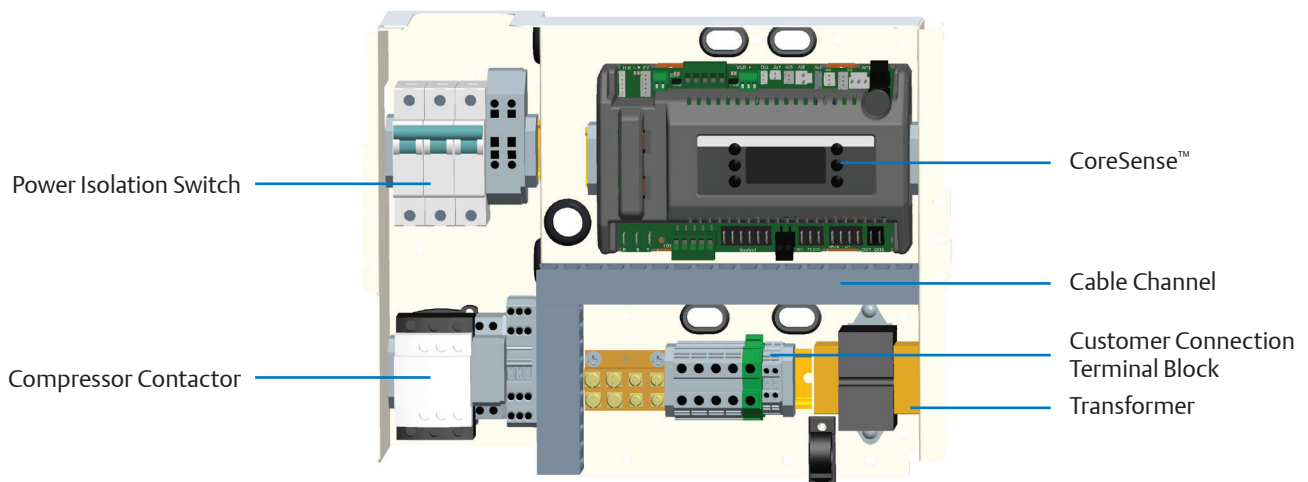

Figure 4. CoreSense™ and Intelligent Store Module Layout

Product Specification

For application envelope, envelope varies according to applications and refrigerants. Please refer to ZX platform product catalogue, product manual, or Copeland™ Brand Products Selection Software.

Qualified Refrigerants and Oils

Refrigerant	Oil
R448 / R449 / R407F / R404A / R507 / R134a	Emkarate RL 32 3MAF Mobil EAL Artic 22 CC
R22	Suniso 3GS

Oils are pre-charged in both compressor and oil separator. Total oil volume (liter) for each unit is shown in the table below:

Model	ZX		ZXB		ZXD		ZXL	
	BOM		Model	BOM	Model	BOM	Model	BOM
	401	451		ALL		ALL		ALL
			ZXB015BE	0.74				
ZX020B0(E)	1.18	1.68	ZXB020BE	0.74			ZXL020B0(E)	1.06
ZX025B0(E)	1.33	1.83	ZXB025BE	0.74			ZXL025B0(E)	1.06
ZX030B0(E)	1.33	1.83	ZXB030BE	1.36			ZXL030B0(E)	1.06
			ZXB035BE	1.36			ZXL035B0(E)	1.74
ZX040B0(E)	1.83	2.33	ZXB040BE	1.36	ZXD040B0(E)	1.74	ZXL040B0(E)	1.74
ZX050B0(E)	1.83	2.33	ZXB050BE	1.89	ZXD050B0(E)	2.27	ZXL050B0(E)	1.74
			ZXB060BE	1.89				
ZX060B0(E)	1.66	2.16			ZXD060B0(E)	2.27	ZXL060B0(E)	2.27
ZX075B0(E)	1.66	2.16			ZXD075B0(E)	2.27	ZXL075B0(E)	2.27
ZX076B0(E)	1.66	2.16						

CoreSense™ for ZX Platform Condensing Unit







LED Descriptions





LED	Status	Description
	ON	Compressor1 is running
	Flashing	Compressor1 is ready to start
	ON	Compressor2 is running
	Flashing	Compressor2 is ready to start
	ON	Condensing fan is running
	ON	Digital compressor is unloading
	ON	Display with °C
	Flashing	Programmable mode

LED	Status	Description
	ON	Browsing the service menu
	Flashing	Browsing the fast access menu
	ON	A new alarm happened
	Flashing	Browsing the alarm menu
	ON	An alarm is occurring
	ON	Liquid line solenoid valve on
	-	Reserved

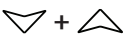

Keyboard Descriptions - Single Button

SET	Set	Display target set point; In programming mode, select a parameter or confirm an operation.
	Reset	Hold for 5 seconds to reset any lockouts if the current state of the controller allows for it to be reset.
	Up	Enter the fast access menu; In programming mode, browse the parameter codes or increases the displayed value.
	Down	In programming mode it browses the parameter codes or decreases the displayed value.
	Service	Enter the service and alarm menu.
	Defrost	Hold for 3 seconds to start a manual defrost or terminate an active defrost. (Not available at the moment).



Keyboard Descriptions - Combined Buttons

	Press and hold for about 3 seconds to lock (Pon) or unlock (PoF) the keyboard.
SET + 	Pressed together to exit programming mode or menu; under rtC and Par, this combination allows the user to go back to previous level.
SET + 	Pressed together for 3 seconds allows access to first level of programming mode.
SET + 	Pressed together for 3 seconds allows access to EXV manual setting.









Controller Display Upon Start-up

Step	Action	Phenomenon and Description
1	Power on controller	All LEDs will light up for 3 seconds.
2		Firmware version will be displayed for 3 seconds.
3		Parameter setting file (bin file) identifier will be displayed for 3 seconds.
4		Normal display (actual suction temperature will be displayed on ZXD unit, condensing temperature will be displayed on ZX/ZXL/ZXB unit)



ZXD Unit Setting Point Modification

Step	Action	Phenomenon and Description
1	Press " SET " > 3 seconds	Press SET button for 3 seconds, the measurement units (°C) will flash together.
2	Press "  " or "  "	Modify the number
3	Press " SET "	Press "SET" to confirm, the number will flash for 2 seconds (or wait for about 10 second to confirm)





Pr1 parameter (1st level) Browse and Modification

Step	Action	Phenomenon and Description
1	Press " SET " + 	Enter menu to select "PAR" (parameter) or "rtC"
2	Press "  " or "  "	Select "PAR (parameter)"
3	Press " SET "	Confirm, select, and browse Pr1 parameters
4	Press "  " or "  "	Browse Pr1 parameters
5	Press " SET "	View the actual number of the Pr1 parameters
6	Press "  " or "  "	Modify the actual number of the Pr1 parameters
7	Press " SET "	Press "SET" : The number will flash for 3 seconds and confirm the modification; Will go to the next Pr1 parameter
8	Press " SET " + 	Exit (or exit automatically after waiting for 120 seconds)



Quick Access Menu Browse - Sensors Status and Actual Values

Step	Action	Phenomenon and Description
1	Press “  ”	Enter quick access menu, will display “P1P” (Press “Up” or “Down” to view other sensors)
2	Press “ SET ”	View the actual value of “P1P”
3	Press “ SET ”	Change to next Sensor code
4	Press “ SET ” + “  ”	Exit (or exit automatically after waiting for 60 seconds)
<p>Sensor Code and Values Descriptions (“nP”, “noP”, or “nA” mean that the sensor does not exist; “Err” means that the sensor fails, out of range, disconnected, or does not configure correctly)</p>		<ul style="list-style-type: none"> • P1P : suction pressure sensor (only for ZXD unit) • P2t : condensing temperature ((mid-coil) sensor) • P2P : pressure sensor (not used) • P3 : discharge line temperature sensor • P4 : PHE vapor inlet temperature sensor • P5 : PHE vapor outlet temperature sensor • P6 : ambient temperature sensor • P7 : temperature sensor (not used) • SH : PHE superheat • oPP : EXV opening step • LLS : the status of liquid line solenoid valve • Std : Condensing temperature setting point • Aoo : The percentage of the analog output • dSo : percentage of the PWM output driving the valve of the Digital Scroll compressor • Lt : min cold room temperature (may not be available) • Ht : max cold room temperature (may not be available) • HM : Time menu

Access Alarm Code (Maximum of 50 record)

Step	Action	Phenomenon and Description
1	Press “  ”	Display “SEC”
2	Press “ SET ”	Display “A01”
3	Press “  ”	Display alarm code in “A01”
4	Press “  ”	Display “A02”
5	Press “  ”	Display alarm code in “A02”
6	...	
7	Press “ SET ” + “  ”	Exit (or exit automatically after waiting for 15 seconds)

Exact Timing of the Alarm

Step	Action	Phenomenon and Description
1	Press "  "	Display "SEC"
2	Press "SET"	Display "A01"
3	Press "  "	Display alarm code in "A01"
4	Press "SET"	Display "Hr"
5	Press "  "	Display the alarm exact timing: hour
6	Press "  "	Display "Min"
7	Press "  "	Display the alarm exact timing: minute
8	Press "  "	Display "dAy"
9	Press "  "	Display the alarm exact timing: day
10	Press "  "	Display "Mon"
11	Press "  "	Display the alarm exact timing: month
12	Press "  "	Display "yEA"
13	Press "  "	Display the alarm exact timing: year
14	Press "SET" + "  "	Exit (or exit automatically after waiting for 15 seconds)

Upload the Program from the Controller to Hot-Key

Step	Action	Phenomenon and Description
1	Inert Hot-Key when the controller is ON	
2	Press "  "	the "uPL" message appears followed a by a flashing "End" label (Note: if display "Err", it means it fails to upload program to Hot-Key. Please restart the process.)
3	Press "SET"	"End" will stop flashing
4	Turn-off the controller and remove Hot-Key	
5	Turn-on the controller	

Download the Program from Hot-Key to Controller

Step	Action	Phenomenon and Description
1	Turn-off the controller	
2	Insert Hot-Key	
3	Turn-on the controller	The “doL” message will blink followed a by a flashing “End” label (Note: if display “Err”, it means it fails to download program to the controller. Please restart the process.)
4		Controller will restart working with the new parameters after 10 seconds
5	Remove Hot-Key	

Network Wiring

Dixell XWEB300D Serial Address

- Connect to the ModBUS network using cable with 2 or 3 shielded wires, minimum section 0.5mm² (e.g. BELDEN8772)
- Do not connect shield to ground.
- Do not connect the “Gnd” terminal.
- Remember to draw a map of the line. This will help you to find an error if something is wrong.
- RS485 devices are polarity sensitive.

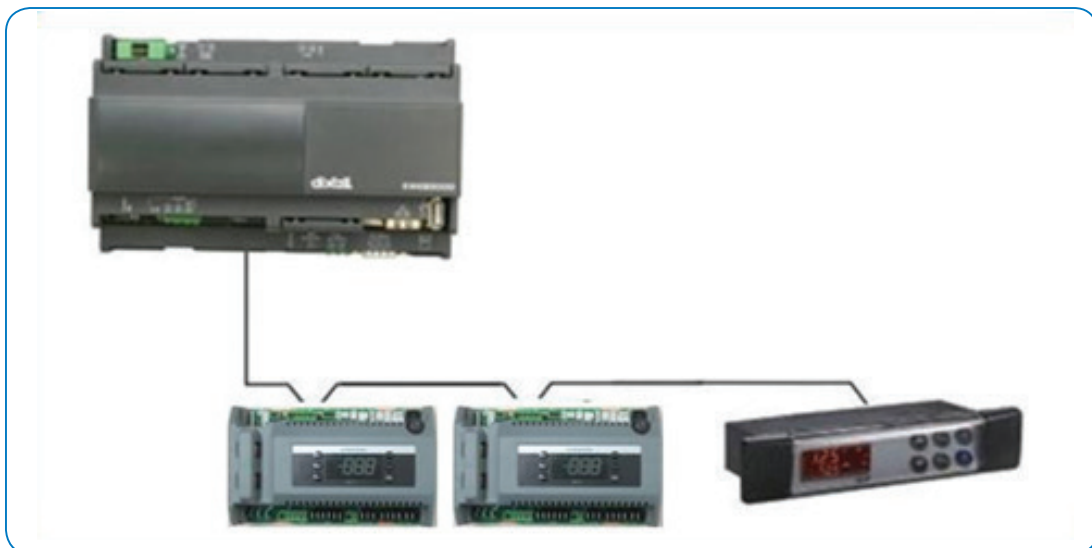

Figure 5. Correct Network Wiring

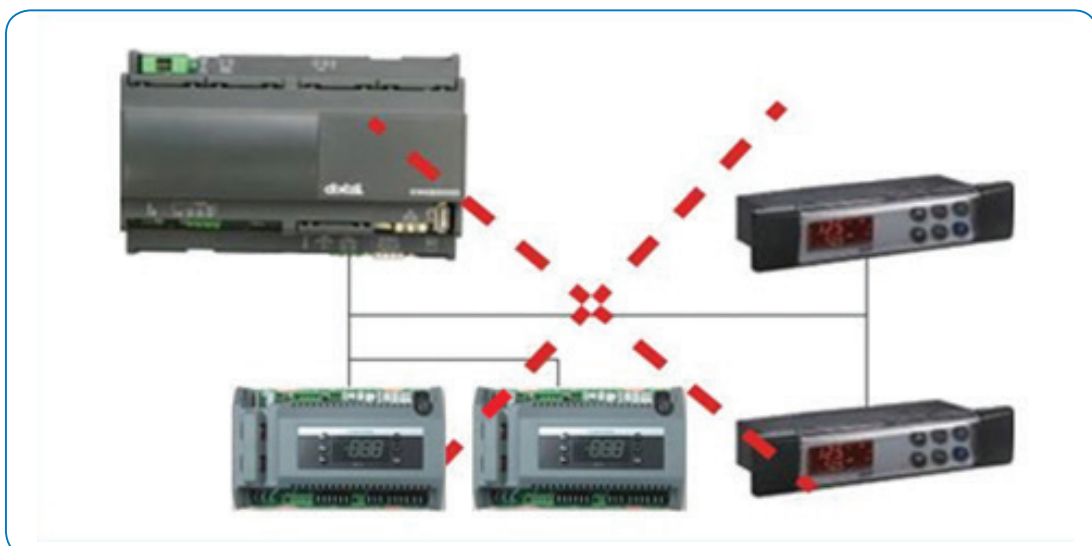

Figure 6 . Incorrect Network Wiring

Termination Resistor for XWEB300D

If XWEB300D is placed at the beginning or at the end of the line, please install its termination resistor by adding a jumper in position 2 (JMP2 on the back side of the unit). Do not add the jumper if XWEB300D is placed in the middle of the RS485 line.

ZX CDU Connected to XWEB300D

ZX CDU connected to the Dixell XWEB300D with the Intelligent Store Solution Module using RS485 ModBUS.

Connect the ZX CDU to the ModBUS network as shown in Figure 7. Connect the network cable to the three-terminal connector on the XWEB300D port that has been configured as ModBUS port (COM 12, 13, 14).

Connect port “13” of XWEB300D to port “D0485 +” of CoreSense™ and port “12” of XWEB300D to port “D1485 -” of CoreSense for RS485 communication.

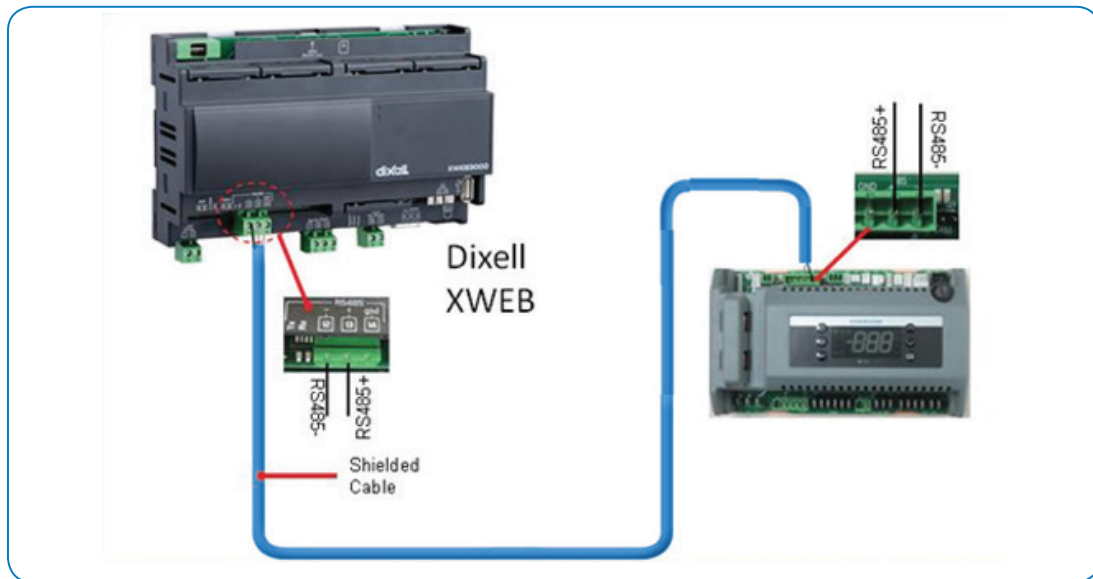

Figure 7. XWEB300D Connected to the Intelligent Store Solution Module

Dixell XWEB300D Configuration

XWEB300D is compatible with ZX CDU if XWEB has the library of ZX controller CoreSense.

Login into XWEB

- Go to Information → Information
- If this is not present, follow the steps below.

Open Dixell website <http://www.dixell.com/xweb300d-xweb500-xweb500d/eng/>, then login (register required)

- Go to Support → System sw update → XWEB300D XWEB500 XWEB500D
- Download the upgrade package With your web-browser, login into XWEB
- Go to Information → System Update menu

Provide the XW5 patch file

Once file has been selected wait until the upgrade procedure ends (XWEB reboots)

Verify the installation ended successfully by checking into the menu

- Go to Information → Information for string

Log in again and set up the ZX CDU

- Go to Configuration → Devices drop-down menu
- Go to Actions → New
- Enter device name in the Name field (e.g. ZX CDU)
- Select “XCM25D” in the Model field
- Enter the ModBUS address in the RS 485 address field
 - Refer to setting of parameter “t01” in pr2 level in CoreSense™ (default setting is “1”)
- Click New

Installation

Copeland ZX condensing units are delivered with a holding charge of neutral gas. The condensing unit should be located in such a place to prevent any dirt, plastic bag, leaves or papers from covering the condenser and its fins. The unit must be installed without restricting the airflow. A clogged condenser will increase the condensing temperature, thus reduce the cooling capacity, and lead to a high-pressure switch tripping. Clean the condenser fins on a regular basis.

Condensing Unit Handling

Transport and Storage

Move ZX/ZXB/ZXD/ZXL unit only with appropriate mechanical or handling equipment according to weight. Keep in the upright position. Do not stack single boxes on top of each other without pallet in any case. Keep the packaging dry at all times.

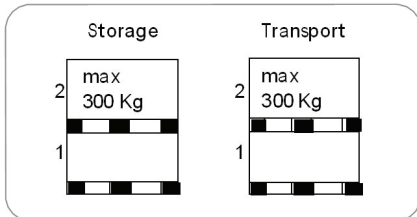

Net Weight

ZX		ZXB		ZXD		ZXL	
Model	Weight (kg)	Model	Weight (kg)	Model	Weight (kg)	Model	Weight (kg)
ZX020B0(E)	76	ZXB015BE	79	ZXD040B0(E) ²	104	ZXL020B0(E)	79
ZX025B0(E)	79	ZXB020BE	81	ZXD050B0(E) ³	112	ZXL025B0(E)	81
ZX030B0(E)	79	ZXB025BE	81	ZXD060B0(E) ⁴	114	ZXL030B0(E)	81
ZX040B0(E) ¹	91	ZXB030BE	93	ZXD075B0(E) ⁵	122	ZXL035B0(E)	93
ZX050B0(E)	108	ZXB035BE	93			ZXL040B0(E)	93
ZX060B0(E)	112	ZXB040BE	106			ZXL050B0(E)	106
ZX075B0(E)	118	ZXB050BE	116			ZXL060B0(E)	116
ZX076B0(E)	121	ZXB060BE	121			ZXL075B0(E)	121

Notes:

¹ 100 kg for models under 60 Hz TF5/7 and 50 Hz PFJ

² 109 kg for models under 60 Hz TF7

³ 117 kg for models under 60 Hz TF7

⁴ 121 kg for models under 60 Hz TF7

⁵ 127 kg for models under 60 Hz TF7

Electrical Connection

Power Supply

The ZX condensing unit electrical connection to the power supply must be made by qualified technicians, who should refer to the electrical diagrams located inside the electric connection panel. The units are designed for below power supply at $\pm 10\%$ voltage tolerance. The circuit breaker must be switched off before opening the front panel.

BOM	Codes	HZ	Phase	Voltages
ALL	PFJ	50	1	220/240
ALL	TFD	50	3	380/420
ALL	TF7	60	3	380
401/451	TF5	60	3	230
471	TF5	60	3	200

Electrical Wiring

Before commissioning, ensure that neutral “N” wire is connected to the terminal block (“N” furthest to the right). After proper connection of the ZX condensing unit, the control LED on the power board and control board will light up. For more details, see wiring diagrams. Customers’ wire size needs to be selected to allow for the maximum operation current of each unit.

Unit	Unit MOC (A)
ZX020BE-TFD	5.7
ZX030BE-TFD	8.0
ZX040BE-TFD	11.1
ZX050BE-TFD	14.4
ZX060BE-TFD	14.7
ZX075BE-TFD	15.6
ZX076BE-TFD	15.6
ZX020B0-TFD	5.3
ZX030B0-TFD	8.8
ZX040B0-TFD	9.8
ZX050B0-TFD	13.6
ZX060B0-TFD	14.7
ZX075B0-TFD	15.6
ZX076B0-TFD	15.6
ZX020BE-TF5	11.3
ZX030BE-TF5	15.4
ZX040BE-TF5	20.7
ZX050BE-TF5	24.6
ZX060BE-TF5	28.7
ZX075BE-TF5	27.4
ZX020B0-TF5	11.3
ZX030B0-TF5	15.4
ZX040B0-TF5	20.7
ZX050B0-TF5	24.6
ZX060B0-TF5	28.7
ZX075B0-TF5	27.4
ZX020BE-TF7	8.3
ZX030BE-TF7	8.3
ZX040BE-TF7	12.2
ZX050BE-TF7	15.2
ZX060BE-TF7	15.3
ZX075BE-TF7	17.2
ZX020B0-TF7	8.3
ZX030B0-TF7	8.3
ZX040B0-TF7	12.2
ZX050B0-TF7	15.2
ZX060B0-TF7	15.3
ZX075B0-TF7	17.2
ZX020BE-PFJ	13.6
ZX025BE-PFJ	13.2
ZX030BE-PFJ	17.2
ZX040BE-PFJ	24.3
ZX020B0-PFJ	13.6
ZX025B0-PFJ	13.2
ZX030B0-PFJ	17.2
ZX040B0-PFJ	24.3

Unit	Unit MOC (A)
ZXL020BE-TFD	6.5
ZXL025BE-TFD	6.9
ZXL030BE-TFD	7.5
ZXL035BE-TFD	8.3
ZXL040BE-TFD	10.0
ZXL050BE-TFD	13.5
ZXL060BE-TFD	15.3
ZXL075BE-TFD	16.2
ZXL020B0-TFD	6.0
ZXL025B0-TFD	6.4
ZXL030B0-TFD	7.0
ZXL035B0-TFD	7.4
ZXL040B0-TFD	9.0
ZXL050B0-TFD	11.7
ZXL060B0-TFD	12.8
ZXL075B0-TFD	15.2
ZXL020BE-TF5	12.4
ZXL025BE-TF5	13.5
ZXL030BE-TF5	15.5
ZXL035BE-TF5	15.7
ZXL040BE-TF5	23.2
ZXL050BE-TF5	25.7
ZXL060BE-TF5	31.2
ZXL075BE-TF5	33.4
ZXL020B0-TF5	10.9
ZXL025B0-TF5	12.0
ZXL030B0-TF5	14.0
ZXL035B0-TF5	15.5
ZXL040B0-TF5	20.0
ZXL050B0-TF5	22.6
ZXL060B0-TF5	27.4
ZXL075B0-TF5	33.2
ZXL020BE-TF7	7.3
ZXL025BE-TF7	7.2
ZXL030BE-TF7	8.4
ZXL035BE-TF7	9.7
ZXL040BE-TF7	12.7
ZXL050BE-TF7	14.8
ZXL060BE-TF7	18.1
ZXL075BE-TF7	18.6
ZXL020B0-TF7	6.5
ZXL025B0-TF7	6.7
ZXL030B0-TF7	7.7
ZXL035B0-TF7	9.1
ZXL040B0-TF7	11.9
ZXL050B0-TF7	13.2
ZXL060B0-TF7	16.4
ZXL075B0-TF7	17.1

Unit	Unit MOC (A)
ZXD040BE-TFD	9.5
ZXD050BE-TFD	12.9
ZXD060BE-TFD	13.0
ZXD075BE-TFD	15.6
ZXD076BE-TFD	15.6
ZXD040B0-TFD	11.6
ZXD050B0-TFD	14.4
ZXD060B0-TFD	14.1
ZXD075B0-TFD	16.8
ZXD076B0-TFD	16.8
ZXD040BE-TF7	11.5
ZXD050BE-TF7	14.2
ZXD060BE-TF7	16.2
ZXD075BE-TF7	17.6
ZXD040B0-TF7	12.2
ZXD050B0-TF7	15.0
ZXD060B0-TF7	15.8
ZXD075B0-TF7	20.3
ZXB015BE-TFD	6.5
ZXB020BE-TFD	6.9
ZXB025BE-TFD	7.5
ZXB030BE-TFD	8.3
ZXB035BE-TFD	10.0
ZXB040BE-TFD	13.5
ZXB050BE-TFD	15.3
ZXB060BE-TFD	16.2

Caution! Unit should be powered on at all times except during service. Failure to do so can result in component failure.

Refrigeration Piping Installation

All interconnecting pipes should be of refrigeration grade, clean, dehydrated and must remain capped at both ends until installation. Even during installation, if the system is left for any reasonable period of time (say two hours), pipes should be re-capped to prevent moisture and contaminants from entering the system.

Do not assume that the service connection sizes on the unit (at the service valves) are the correct size to run your interconnecting refrigeration pipes. The service valve sizes have been selected for convenience of installation and in some cases (larger units) these may be considered too small. However for the very short pipe run within our units, these service connection sizes are adequate. All interconnecting pipes should be sized to satisfy the duty required.

Usually the suction line is insulated, but the liquid line is not. However the liquid line can pick up additional heat from the ambient and adversely affect the sub-cooling desirable for the liquid refrigerant before it enters the expansion valve.

The pipe should be sized to ensure optimum performance and good oil return. The sizing must also take into account the full capacity range through which this particular unit will need to operate.

Pipe runs should be kept as short as possible, using the minimum number of directional changes. Use large radius bends and avoid trapping of oil and refrigerant. This is particularly important for the suction line. The suction line should ideally slope gently towards the unit. Recommendation slope is 1/200~1/250. P traps, double risers and reduced pipe diameters may be required for suction lines where long vertical risers cannot be avoided. All pipes should be adequately supported to prevent sagging which can create oil traps. The recommended pipe clamp support distance is shown in the table.

Tube Size	Max distance between 2 clamp support
12.7mm (1/2 inch)	1.20 m
16.0mm (5/8 inch)	1.50 m
22.0mm (7/8 inch)	1.85 m
28.5mm (1 1/8 inch)	2.20 m

ZXL Liquid Line Insulation

ZXL liquid line should be insulated with a 19 mm insulation thickness. Temperature could be as low as -15°C.

Brazing Recommendations

Maintain a flow of oxygen-free nitrogen through the system at a very low pressure during brazing. Nitrogen displaces the air and prevents the formation of copper oxides in the system. If copper oxidization is allowed to form, the copper oxide material can later be swept through the system and block screens such as those protecting capillary tubes, thermal expansion valves, and accumulator oil return holes. This minimizes any entry of contaminants and moisture.

- Remove the liquid line connection cap.
- Then remove the suction connection cap.
- Open both valves midway. Care should be taken to avoid the holding charge from releasing too quickly.
- Be sure tube fitting inner diameter and tube outer diameter are clean prior to assembly.
- Since both tubes are extended from the condensing unit housing, we recommend insulating the housing by using a wet cloth on the copper tubing.
- Recommended brazing materials: a copper / phosphorous or copper / phosphorous / silver alloy rod should be used for joining copper to copper whereas to join dissimilar or ferric metals, use a silver alloy rod, either flux coated or with a separate.
- Use a double tip torch.

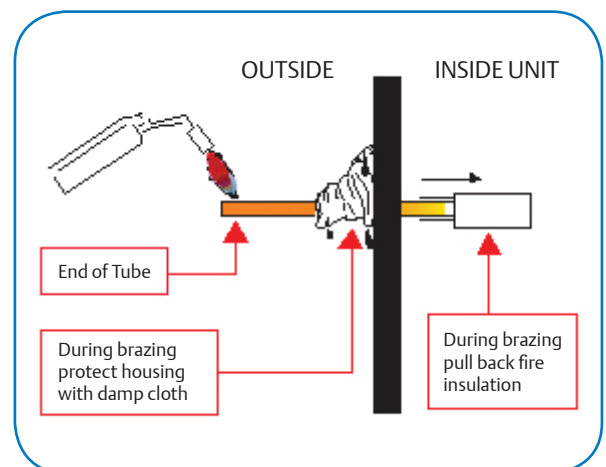

Expansion Valve Selection for Low Ambient Application

For systems expected to operate in varying ambient conditions – namely summer and winter temperatures – the expansion valve (TXV or EXV) sizing should take into consideration the maximum expected saturated condensing temperature at high ambient conditions (summer) and the minimum expected saturated condensing temperature, set at -25°C, during low ambient conditions (winter).

The chosen expansion valve’s operating capacities should be well within these limits to ensure satisfactory system performance.

In the event that different expansion valves come up for the two conditions, the valve for low ambient condition should be selected. This means that at higher ambient, the valve will be oversized. However, if the valve at the high ambient is selected, it may be too small during low ambient condition.

Location and Fixing

The unit should always be installed in a location that ensures clean air flow. It is recommended that a clearance of 300 mm from the wall (or the next unit) be maintained from the unit’s left and rear panels whereas a clearance of 500 mm must be maintained from the unit’s right, top and front panels (seen facing the front of the unit). Both service access and airflow have been considered in making these recommendations. Where multiple units are to be installed in the same location, the contractor needs to consider each individual case carefully. There can be many variations of unit quantities and available space and it is not the intention of this manual to go over these. Ideally, the unit should be mounted on a solid concrete slab with anti-vibration pads between unit feet and concrete. However the ZX condensing unit has also been designed for wall mounting on suitable brackets. Wall mounting brackets are not included. Another factor to consider in finding a good installation site is the direction of the prevailing wind. For example if the air leaving the condenser faces the prevailing wind, the air flow through the condenser can be impeded, causing high condensing temperatures ultimately resulting in reducing unit life. A baffle is a remedy for this situation.

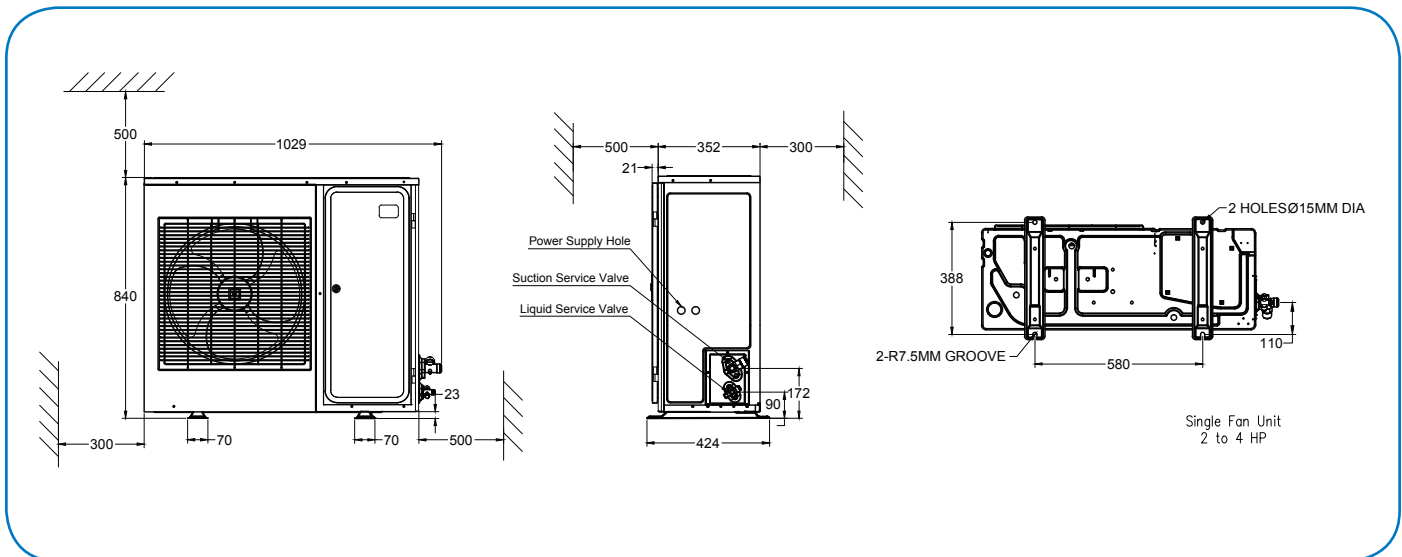

Fixing dimensions and distances - Single fan unit

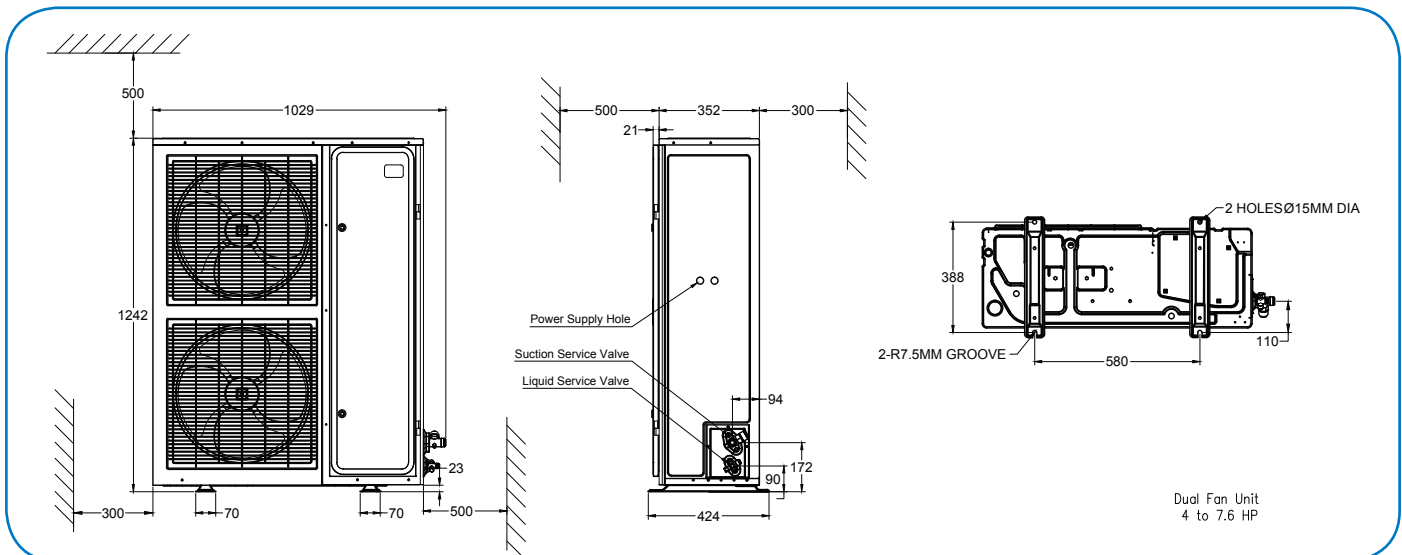

Fixing dimensions and distances - Dual fan unit

Start Up and Operation

Before commissioning, ensure that all valves on the condensing unit are fully opened.

Evacuation

The evacuation procedure is based upon achieving an actual system vacuum standard and is not time dependent. Before the installation is put into commission, it has to be evacuated with a vacuum pump. Proper evacuation reduces residual moisture to 50ppm. The installation of adequately sized access valves at the furthest point from the compressor in the suction and liquid lines is advisable. To achieve undisturbed operation, the compressor valves are closed and the system is evacuated down to 0.3 mbar / 0.225 Torr. Pressure must be measured using a vacuum pressure (Torr) gauge on the access valves and not on the vacuum pump; this serves to avoid incorrect measurements resulting from the pressure gradient along the connecting lines to the pump.

Charging Procedure

Refrigerant charging procedure

The scroll compressor design requires system charging as quickly as possible with liquid refrigerant into the liquid line. This will avoid running the compressor under conditions where there is insufficient suction gas. Sufficient suction gas is available to cool not only the motor but also the scrolls. Temperature builds up very quickly in the scrolls if this is not done. Do not charge vapor (gas) refrigerant into the ZX Scroll unit. The suction service valve must not be fully closed at any time while the compressor is running. To do so would cause damage to the compressor in the same manner as explained above. This valve is provided for ease of connection and for the fitting of service gauges without removing the unit panel. It is recommended to charge the ZX unit with refrigerant via its service valves. It is recommended to break the vacuum in the system with a partial charge of the refrigerant, before starting the system. For charge adjustment, it is recommended to check the liquid sight glass just before the expansion valve.

Oil charging procedure

Emerson ZX condensing units are supplied only with a compressor oil charge. After commissioning, the oil level should be checked and topped up if necessary. The oil level should be approximately halfway up the sight glass (ZXL/ZXD units). Oil can be charged through the Schraeder valve on suction valve.

Scroll compressor rotation direction

Scroll compressors, like several other types of compressors, will only compress in one rotational direction. The direction of rotation is not an issue with single-phase compressors since they will always start and run in the proper direction. Three-phase compressors will rotate in either direction depending upon the phasing of the power. Since there is a 50-50 chance of connecting power in such a way that causes rotation in the reverse direction, it is important to include notices and instructions in appropriate locations on the equipment to ensure proper rotation direction when the system is installed and operated.

Maximum compressor cycle

Maximum permitted starts per hour is 10.



Check before starting & during operation

Both valves should be fully opened on the liquid line, in order to prevent trapping liquid.

- Check that all valves are fully opened.
- After starting and operation conditions are stabilized, it is recommended to check the oil level in compressor(s) and see if there is a need to add oil to ensure a sufficient oil level (halfway up the sight glass).

Controller Initialization Message

When the unit is initially powered on, the controller will display.







Step	Action	Phenomenon and Description
1	Power on controller	All LEDs will light up for 3 seconds.
2		Firmware version will be displayed for 3 seconds.
3		Parameter setting file (bin file number) identifier will be displayed for 3 seconds.
4		Normal display (actual suction temperature will be displayed on ZXD unit, condensing temperature will be displayed on ZX/ZXL/ZXB unit)

Bin Files Number Range









Bin Number Range	Family
1 to 200	ZX
201 to 300	ZXB
301 to 500	ZXL
501 to 600	ZXD
800 to 806	Service Part

After installation and initial power on, it is critical to double check the parameters below.



RTC (Real Time Clock) Setting

Step	Action	Phenomenon and Description
1	Press SET + 	Enter menu to select "PAr" (parameter) or "rtC"
2	Press  or 	Select "rtC"
3	Press SET	"n01", minute "n02", hour "n03", day "n04", month "n05", year (last two digits)
4	Press SET	Display actual value
5	Press  or 	Modify the value
6	Press SET	Press "SET" : the value will flash for 3 second, then move to the next value
7	Press SET + 	Exit to "rtC"
8	Press SET + 	Exit to main menu (or wait for 120 seconds and exit atomically)

Refrigerants

Step	Action	Phenomenon and Description
1	Press SET + 	Enter menu to select "PAr" (parameter) or "rtC"
2	Press  or 	Select "PAr (parameter)"
3	Press SET	Confirm selection
4	Press  or 	Browse to parameter C07
5	Press SET	Confirm selection
6	Press  or 	Select refrigerant to be used
7	Press SET	The number will flash for 3 seconds and confirm the refrigerant selection
8	Press SET + 	Exit (or exit automatically after waiting for 120 seconds)

Evaporating Temperature (ZXD Only)

Step	Action	Phenomenon and Description
1	Press “ SET ” > 3 seconds	Press “ SET ” button for more than 3 seconds, the measurement units (°C) will flash together.
2	Press “  ” or “  ”	Modify the number for Target Evaporating Temperature
3	Press “ SET ”	Press “ SET ” to confirm, the number will flash for 2 seconds (or wait for about 10 seconds to confirm)

Alarm Codes

Level	Descriptions
Warning	Unit (including compressor) is running but some data reach unsafe area; alarm dry-contact will not close; reset automatically
Alarm	Unit (including compressor) may run not with full functions; alarm dry-contact will not close; reset automatically
Lock	Unit (including compressor) stops working; alarm dry-contact will close; manual reset is needed

Alarm Code	Description	Possible Reason	Action	Reset
Hardware error				
E01	Suction pressure probe failure alarm	Probe failure or out of range	No (ZXD Unit Only)	Automatic Reset when the probe restarts working
E02	Condensing temperature probe failure alarm	Probe failure or out of range (-40 ~ 110°C)	Function: fan speed control is disabled	Automatic Reset when the probe restarts working
E03	Discharge temperature probe failure alarm	Probe failure or out of range (-40 ~ 180°C)	Function: discharge temperature protection is disabled	Automatic Reset when the probe restarts working
E04	PHE vapor inlet temperature probe failure alarm	Probe failure or out of range (-40 ~ 110°C)	Function: PHE Superheat Control is disabled(ZXL/ZXB unit only)	Automatic Reset when the probe restarts working
E05	PHE vapor outlet temperature probe failure alarm	Probe failure or out of range (-40 ~ 110°C)	Function: PHE Superheat Control is disabled(ZXL/ZXB unit only)	Automatic Reset when the probe restarts working
E06	Ambient temperature probe failure alarm	Probe failure or out of range (-40 ~ 110°C)	Related functions are disabled	Automatic Reset when the probe restarts working
E09	Current sensor 1 error alarm	Out of range	Related functions are disabled	Automatic Reset when the probe restarts working
E10	Current sensor 2 error alarm	Out of range	Related functions are disabled	Automatic Reset when the probe restarts working
E11	Voltage sensor 1 error alarm	Out of range	Related functions are disabled	Automatic Reset when the probe restarts working
E12	Voltage sensor 2 error alarm	Out of range	Related functions are disabled	Automatic Reset when the probe restarts working
E13	Voltage sensor 3 error alarm	Out of range	Related functions are disabled	Automatic Reset when the probe restarts working

Alarm Code	Description	Possible Reason	Action	Reset
Electrical Error				
E20	Missing phase alarm	One or two phases of compressor power supply lost or Voltage sensors do not work (3-ph unit only)	The compressor will be tripped	Automatically with time delay
L20	Missing phase lock	Missing phase alarm happened frequently	The compressor will be tripped and the unit will be locked	Press "Start" >5 sec or manually power-off and power-on
L21	Wrong phase sequence lock	Compressor power supply has wrong sequence (3-phase unit only)	The compressor will be tripped and the unit will be locked	Press "Start" >5 sec or manually power-off and power-on
E22	Imbalanced 3-phase warning	3-Ph currents are not balanced (3-Ph unit only)	No	Automatically with time delay
E23	Over current alarm	Compressor current is larger than settings	The compressor will be tripped	Automatically with time delay
L23	Over current lock	Over current alarm happens frequently	The compressor will be tripped and the unit will be locked	Press "Start" >5 sec or manually power-off and power-on
E24	Compressor running circuit open alarm	Compressor running circuit open (1-ph unit only)	The compressor will be tripped	Automatically with time delay
L24	Compressor running circuit open lock	Running circuit open alarm happens frequently	The compressor will be tripped and the unit will be locked	Press "Start" >5 sec or manually power-off and power-on
E25	Compressor starting circuit open alarm	Compressor starting circuit open (1-ph unit only)	The compressor will be tripped	Automatically with time delay
L25	Compressor starting circuit open lock	Compressor starting circuit open alarm happens frequently	The compressor will be tripped and the unit will be locked	Press "Start" >5 sec or manually power-off and power-on
E26	Low voltage alarm	Voltage is lower than settings; or voltage sensors do not work	The compressor will be tripped	Automatically with time delay
L26	Low voltage lock	Low voltage alarm happens frequently	The compressor will be tripped and the unit will be locked	Press "Start" >5 sec or manually power-off and power-on
E27	Over voltage alarm	Voltage is higher than settings	The compressor will be tripped	Automatically with time delay
L27	Over voltage lock	Over voltage alarm happens frequently	The compressor will be tripped and the unit will be locked	Press "Start" >5 sec or manually power-off and power-on
E28	Compressor internal protector open warning	Compress internal protector is open; or current sensors do not work	No	The compressor will be tripped
E30	No controller power supply alarm	Controller lost power supply		

Alarm Code	Description	Possible Reason	Action	Reset
Refrigeration system error				
E40	High pressure switch alarm	High pressure switch is open	The compressor will be tripped	Automatically when HP switch closes
L40	High pressure switch lock	High pressure switch alarm happens frequently	The compressor will be tripped and the unit will be locked	Press "Start" >5 sec or manually power-off and power-on
E41	Low pressure switch alarm	Low pressure switch is open	The compressor will be tripped	Automatically when LP switch closes and time delay
E44	High discharge temperature alarm	Discharge temperature is higher than settings	The compressor will be tripped	Automatically when discharge temperature is lower than settings and time delay
L44	Higher discharge temperature lock	High discharge temperature alarm happens frequently	The compressor will be tripped and the unit will be locked	Press "Start" >5 sec or manually power-off and power-on
E46	High condensing temperature alarm	Condensing temperature is higher than settings	No	Automatically when condensing temperature is lower than settings
E47	EXV Full-open warning	Less refrigerant charge or leakage	No	Automatically when EXV is not at full-open
E48	Less injection warning	Less refrigerant charge or leakage	No	Automatically when PHE super heat is smaller than settings
E50	High side liquid back warning	Suction liquid back or injection too much	No	Automatically when the difference of discharge temperature and condensing temperature is higher than settings and time delay

Misc. Error				
E80	RTC warning	The time is configured for the new controller	No	Automatically when finish time configuration
E81	RTF warning	Communication error between MCU and unit clock	No	Automatically when the communication recovers
E82	Probe configuration error alarm	The same probes are configured	No	Automatically when the probes are configured correctly
E83	Digital inputs configuration error alarm	The same digital inputs are configured	The related functions will be disabled	Automatically when the digital inputs are configured correctly
E84	Compressor configuration error alarm	Digital compressor and solenoid valve configuration does not match	The compressor will not work	Manually power off and power on after the compressor configuration is right
E85	Injection probe configuration error alarm	EXV and injection configuration do not match	EXV will not work	Automatically when injection probe is configured correctly
L86	EEPROM R/W error lock	write/read error into EEPROM	The compressor will tripped and the unit will be locked	Hold "start" button for 5s or manual power off and on, alarm will disappear when the communication between MCU and EEPROM is success.

ZXD-TFD/TF7 Condensing Unit Wiring Diagram

TFD - 380/420V, 50Hz, 3Ph

TF7 - 380V, 60Hz, 3Ph



NOTES:

1. Dashed line " --- " is wired by installer.
2. Neutral "N" and Earth "E" wirings are not shown in harnesses for clarity.
3. In "-461" units, all yellow wires are replaced by white wires.

ATTENTION: Unit Must Be Grounded!

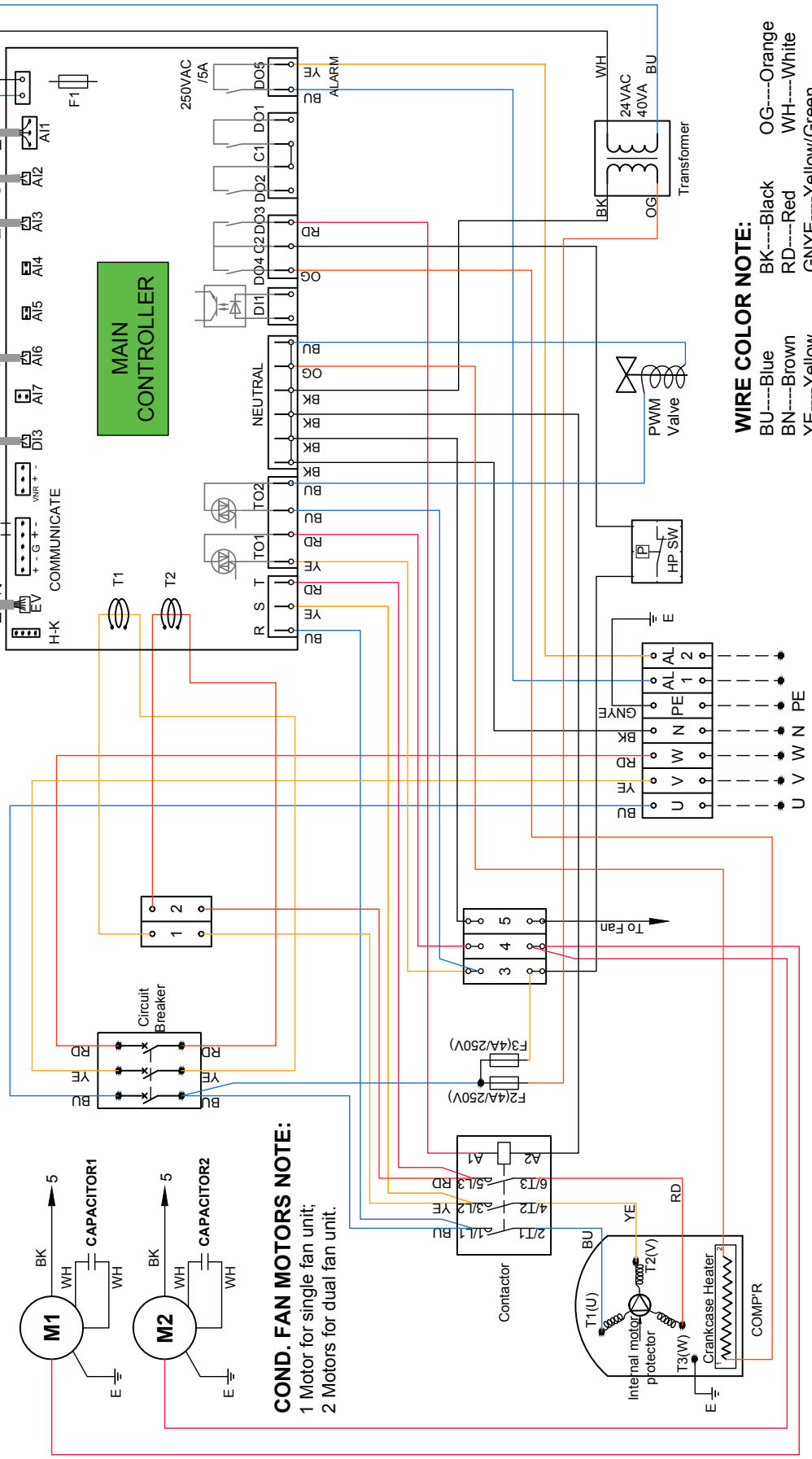

WIRE COLOR NOTE:

- BU---Blue
- BN---Brown
- YE---Yellow
- BK---Black
- RD---Red
- GNYE---Yellow/Green
- OG---Orange
- WH---White

COND. FAN MOTORS NOTE:

- 1 Motor for single fan unit;
- 2 Motors for dual fan unit.

ZX/ZXL Condensing Unit Wiring Diagram

PFJ - 220/240V, 50Hz, 1Ph

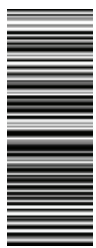

052-2985-00
2014-12-12

ATTENTION: Unit Must Be Grounded!

NOTES:

1. Dashed line " - - - " is wired by installer.
2. Earth "E" wirings are not shown in harnesses for clarity.

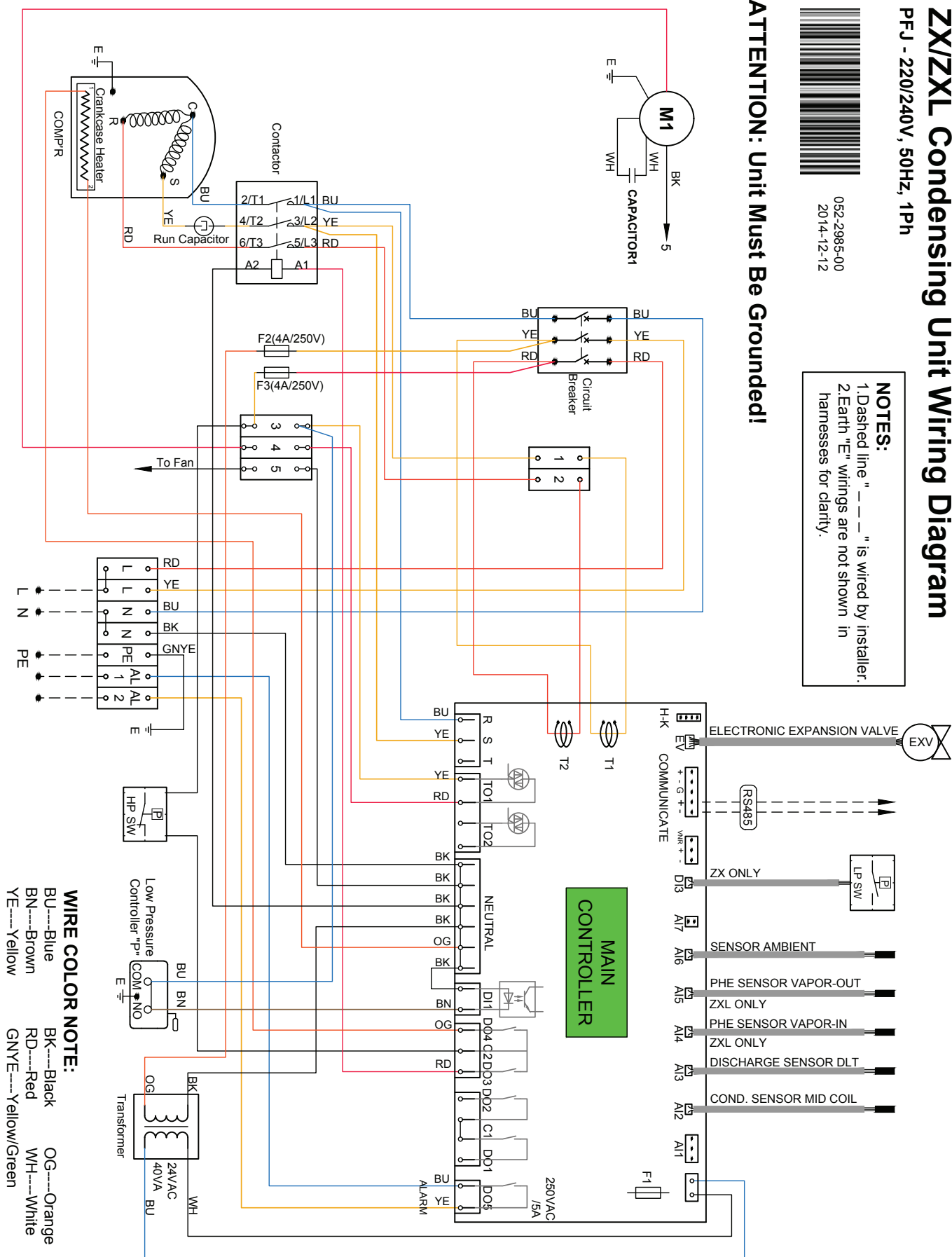

WIRE COLOR NOTE:

- BU---Blue
- BK---Black
- OG---Orange
- BN---Brown
- RD---Red
- WH---White
- YE---Yellow
- GNYE---Yellow/Green

ZX/ZXL-TF5 Condensing Unit Wiring Diagram

TF5 - 401/451: 230V, 60Hz, 3Ph

TF5 - 471: 200V, 60Hz, 3Ph

052-2987-00
2014-12-12



NOTES:

1. Dashed line " --- " is wired by installer.
2. Earth "E" wirings are not shown in harnesses for clarity.

ATTENTION: Unit Must Be Grounded!

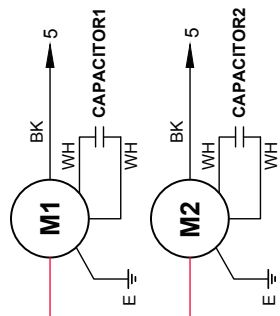

COND. FAN MOTORS NOTE:

- 1 Motor for single fan unit;
- 2 Motors for dual fan unit.

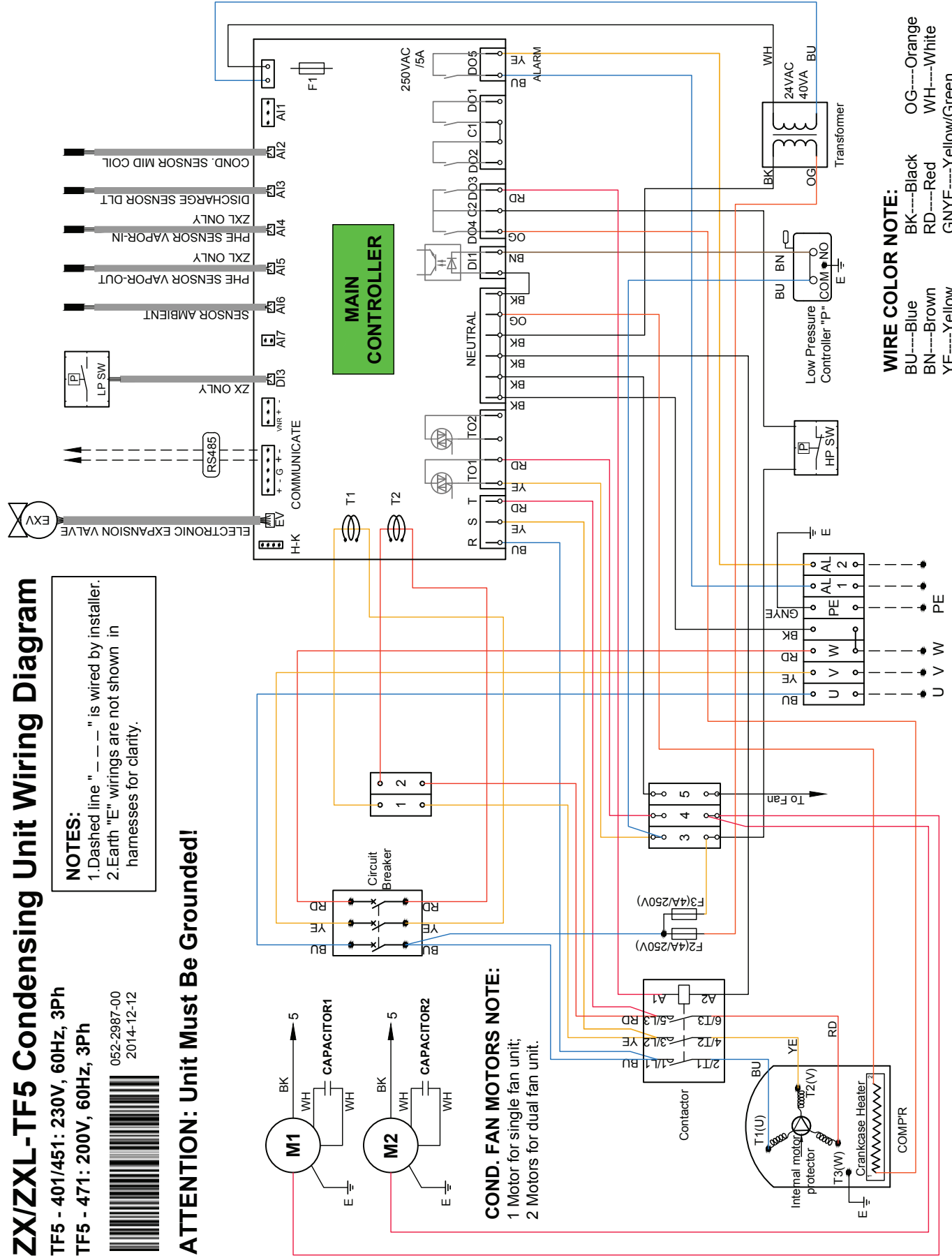

WIRE COLOR NOTE:

- BU----Blue
- BK----Black
- OG----Orange
- BN----Brown
- RD----Red
- WH----White
- YE----Yellow
- GNYE----Yellow/Green

ZX/ZXL/ZXB-TFD/TF7 Condensing

Unit Wiring Diagram

TFD - 380/420V, 50Hz, 3Ph
 TF7 - 380V, 60Hz, 3Ph



052-2989-00
 2014-12-12

NOTES:
 1. Dashed line " _ _ _ " is wired by installer.
 2. Neutral "N" and Earth "E" wirings are not shown in harnesses for clarity.
 3. In " -461" units, all yellow wires are replaced by white wires.

ATTENTION: Unit Must Be Grounded!

COND. FAN MOTORS NOTE:
 1 Motor for single fan unit;
 2 Motors for dual fan unit.

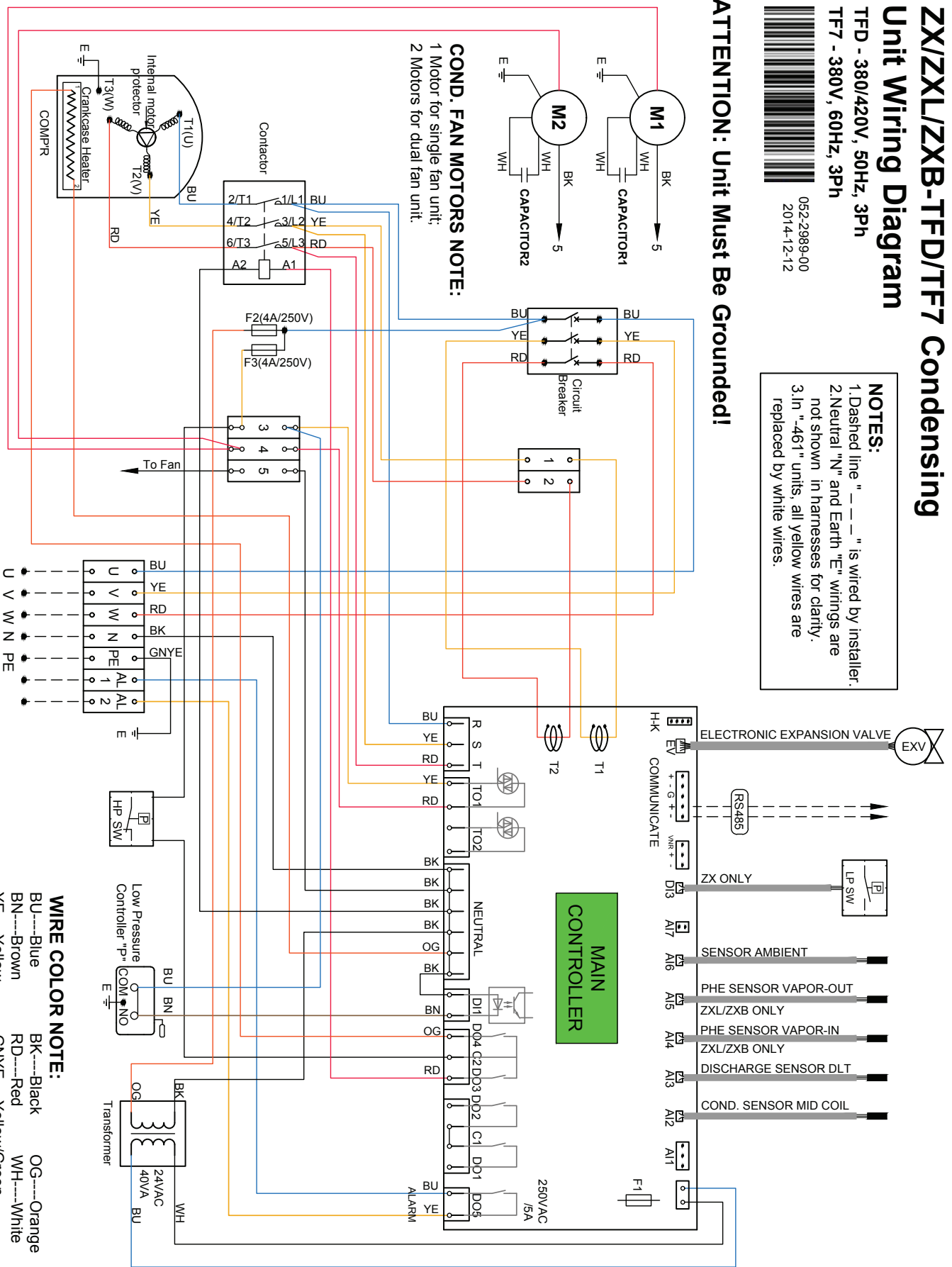

WIRE COLOR NOTE:
 BU---Blue
 BN---Brown
 YE---Yellow
 BK---Black
 RD---Red
 GNYE---Yellow/Green
 OG---Orange
 WH---White

ZX/ZXL/ZXB-TFD/TF7 Condensing BOM 481

Unit Wiring Diagram

TFD - 380/420V, 50Hz, 3Ph

TF7 - 380V, 60Hz, 3Ph



052-3020-00
2015-04-22

NOTES:
1. Dashed line "----" is wired by installer.
2. Earth "E" wirings are not shown in harnesses for clarity.

ATTENTION: Unit Must Be Grounded!

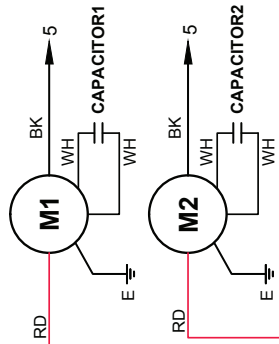

COND. FAN MOTORS NOTE:

- 1 Motor for single fan unit;
- 2 Motors for dual fan unit.

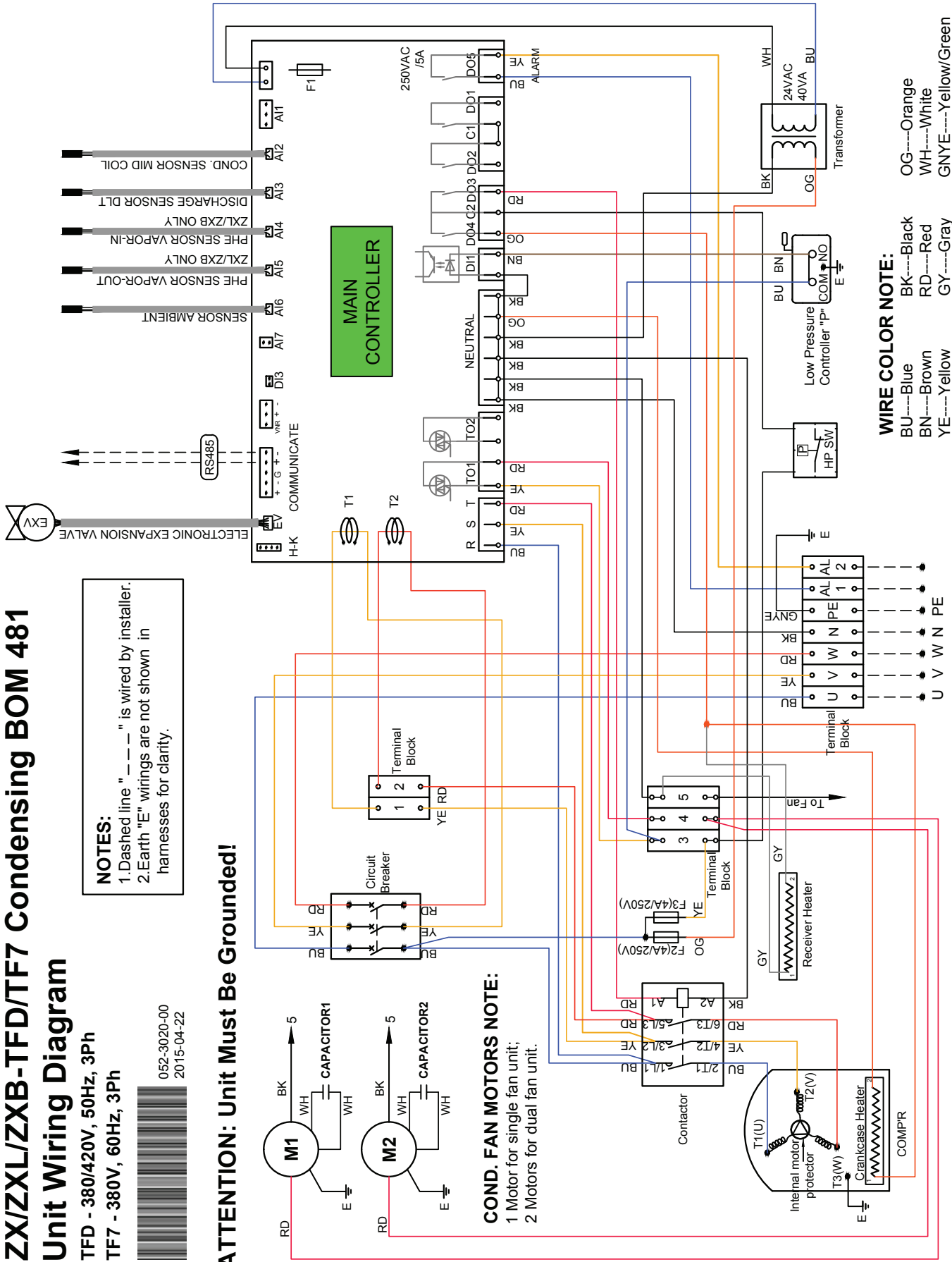

WIRE COLOR NOTE:

- BU----Blue
- BK----Black
- BN----Brown
- RD----Red
- YE----Yellow
- GY----Gray
- OG----Orange
- WH----White
- RD----Red
- GY----Gray
- BNYE----Yellow/Green

General Information

Technical data are correct at the time of printing. Updates may occur, and should you need confirmation of a specific value, please contact Emerson Climate Technologies™ stating clearly the information required.

Emerson Climate Technologies cannot be held responsible for errors in capacities, dimensions, etc., stated herein. Products, specifications, and data in this literature are subject to change without notice.

The information given herein is based on data and tests which Emerson Climate Technologies believes to be reliable and which are in accordance with today's technical knowledge. It is intended for use by persons having the appropriate technical knowledge and skill, at their own discretion and risk. Our products are designed and adapted for fixed locations. For mobile applications, failures may occur.

The suitability for this has to be assured from the plant manufacturer, which may include making appropriate tests.

Note:

The components listed in this catalogue are not released for use with caustic, poisonous or flammable substances. Emerson Climate Technologies cannot be held responsible for any damage caused by using these substances.

Contact Lists

Asia Pacific Headquarters

Emerson Climate Technologies
Suite No. 2503-8, 25/F,
Exchange Tower, 33 Wang Chiu Road,
Kowloon Bay, Kowloon, Hong Kong
Tel: (852) 2866 3108
Fax: (852) 2520 6227

Australia

Emerson Climate Technologies Australia
Pty Ltd
356 Chisholm Road
Auburn NSW 2144, Australia
Tel: (612) 9795 2800
Fax: (612) 9738 1699

China - Beijing

Emerson Climate Technologies (Suzhou)
Co. Ltd
Beijing Sales Office
Room 1017 JianWei Building,
66 Nan Lishi Road, XiCheng District,
Beijing, PRC
Tel: (8610) 5763 0488
Fax: (8610) 5763 0499

China - Guangzhou

Emerson Climate Technologies (Suzhou)
Co. Ltd
Guangzhou Sales Office
508-509 R&F Yinglong Plaza,
No. 76 Huangpu Road West,
Guangzhou, PRC
Tel: (8620) 2886 7668
Fax: (8620) 2886 7622

China - Shanghai

Emerson Climate Technologies
(Suzhou) Co. Ltd
Shanghai Sales Office
1801 Building B, New CaoHejing
International Business Center,
391Guiping Rd, Shanghai, PRC
Tel: (8621) 3418 3968

India - Mumbai

Emerson Climate Technologies (India) Ltd
Delphi B-Wing, 601-602, 6th Floor
Central Avenue, Hiranandani Business Park,
Powai, Mumbai 400076
Tel: (9122) 6786 0793
Fax: (9122) 6662 0500

India - PUNE

Emerson Climate Technologies (India) Ltd
Plot No. 23, Rajiv Gandhi Infotech Park,
Phase - II, Hinjewadi,
Pune 411 057, Maharashtra, India
Tel: (9120) 4200 2000
Fax: (9120) 4200 2099

Indonesia

PT Emerson Indonesia
BSD Taman Tekno 8
Jl. Tekno Widya Blok H10 No 2 & 3
Tangerang Selatan 15314
Indonesia
Tel: (6221) 2666244
Fax: (6221) 2666245

Japan

Emerson Japan Ltd
Shin-yokohama Tosho Building
No. 3-9-5 Shin-Yokohama, Kohoku-ku
Yokohama 222-0033 Japan
Tel: (8145) 475 6371
Fax: (8145) 475 3565

Malaysia

Emerson Electric (Malaysia) Sdn. Bhd.
Level M2, Blk A, Menara PKNS-PJ
Jalan Yong Shook Lin
46050 Petaling Jaya, Selangor, Malaysia
Tel: (603) 7949 9222
Fax: (603) 7949 9333

Middle East & Africa

Emerson Climate Technologies
PO Box 26382
Jebel Ali Free Zone – South
Dubai, UAE
Tel: (9714) 811 8100
Fax: (9714) 886 5465

Philippines

Emerson Climate Technologies
10/F SM Cyber West Avenue, EDSA cor.
West Avenue, Barangay Bungad, Diliman,
Quezon City 1105 Philippines
Tel: (632) 689 7200

South Korea

Emerson Electric Korea Ltd.
3F POBA Gangnam Tower
343, Hakdong-ro, Gangnam-gu,
Seoul 135-820, Republic of Korea
Tel: (822) 3483 1500
Fax: (822) 592 7883

Taiwan

Emerson Electric (Taiwan) Co. Ltd
3F No. 2 DunHua South Road Sec.1,
Taipei (105), Taiwan
Tel: (8862) 8161 7688
Fax: (8862) 8161 7614

Thailand - Bangkok

Emerson Electric (Thailand) Ltd
34th Floor, Interlink Tower,
1858/133, Bangna Trad,
Bangkok 10260, Thailand
Tel: (662) 716 4700
Fax: (662) 751 4241

Vietnam

Emerson Climate Technologies - Vietnam
Suite 307-308,
123 Truong Dinh St., Dist.3
Ho Chi Minh, Vietnam
Tel: (84) 908 009 189

EmersonClimateAsia.com

Asia 02 A01 10 – R01 Issued 10/2015 – GSCAA055

Emerson and Copeland Scroll are trademarks of Emerson Electric Co. or one of its affiliated companies.
©2015 Emerson Climate Technologies, Inc. All rights reserved.



999-0318-00

EMERSON. CONSIDER IT SOLVED.™